



CorHealth 

Healthcare
Solutions

Brilliant Lighting Solutions for Healthcare Environments

At Coronet, we believe the right lighting and ambiance can change people's worlds, and nowhere is that more important than in healthcare settings.

We provide advanced LED luminaire solutions designed to enhance visibility and create a calming atmosphere across various settings—from welcoming lobbies to serene waiting areas, hallways, and patient rooms. Prioritizing energy efficiency, accurate color rendering, and durability, our products are crafted with both healthcare professionals and patients in mind.

A Certified CarbonNeutral Company®, our factory is located in New Jersey; our supply chain is virtually all U.S.-based; and most of our products are BAA and BABA compliant.

Illuminate your facility with Coronet LED, where innovation meets excellence.



Declare.



COMMON AREAS

In hospital common areas like lobbies and waiting rooms, lighting is essential in shaping the overall experience. It sets the mood, influences perception, and enhances comfort. At Coronet, our solutions strike the perfect balance—offering ample illumination while creating a welcoming and serene atmosphere.

Designed to complement various architectural styles and design visions, our fixtures—from striking pendant installations to discreet recessed options—enhance both functionality and aesthetics, ensuring every common area is inviting and effective.





Cove & Perimeter

Coronet's cove and perimeter lighting solutions seamlessly integrate into healthcare settings, providing subtle, indirect illumination that enhances ambiance. With customizable lengths and flexible installation options, these fixtures create inviting atmospheres and accentuate architectural features, ensuring a warm and welcoming environment.



Lalina Cove Lalina Perimeter

Lalina Cove is a flexible mud-in channel system for architectural coves. The optional Wide Asymmetric Optic enhances light projection, and lengths are customizable.



Easy Cove Easy Perimeter

Easy Cove is an easy-install luminaire available in a ceiling version with a WAO for extended ceiling projection and a wall version for perimeter lighting.

Lalina Cove

Lalina Cove is a field-curvable and cuttable mud-in channel system that conforms to architectural coves. Its ceiling-facing precision-engineered asymmetric optic provides subtle, even indirect illumination. For maximum horizontal light projection, choose the Wide Asymmetric Optic (WAO) option.

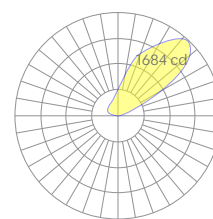
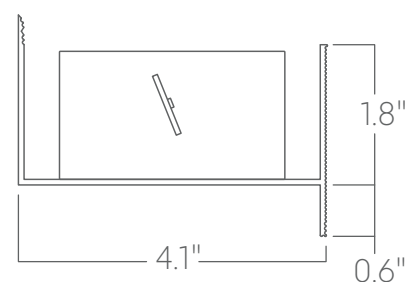

standard diffuser

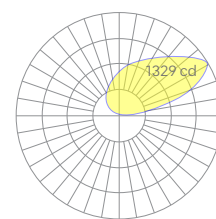

wide asymmetric optic

- Tunable White
- Power Over Ethernet
- CRI > 90
R9 > 50
- Low Glare



Flawless

Flawless wall grazer luminaires feature a 15° optic for optimal grazing. Depth of regress is specifiable for subtle, even vertical illumination.



PG Series

PG Series perimeter luminaires regress into ceilings, providing subtle, even vertical illumination. Available with specifiable 1", 2", 3", or 4" regress.



Geometric Series

Our Geometric Series features a striking collection of fixtures in circles, squares, and rectangular shapes, designed to elevate any space with modern elegance. Each fixture boasts clean lines and a minimalist aesthetic, making them ideal for healthcare settings. Available in various sizes, finishes, and mounting options, these versatile fixtures create dynamic visual interest while providing optimal illumination.

PRD

This modern round architectural fixture offers versatile installation as a suspended pendant light for open ceilings, or as a flush mount for a sleek appearance. Crafted from custom-spun steel with a specially formed convex lens, it enhances aesthetics and functionality. Available in various sizes.

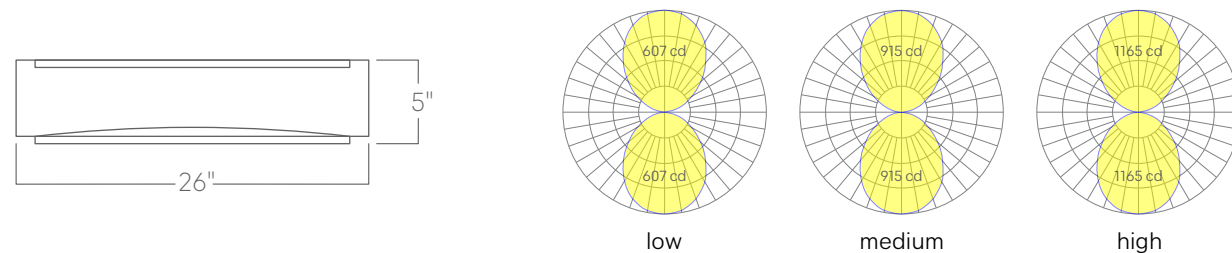

- Tuneable White
- Warm Dim
- Power Over Ethernet
- Declare Listed
- CRI > 90
R9 > 50
- Low Glare



RRD/PRD

RRD is the recessed version of the suspended PRD, featuring architectural round luminaires with a concave lens for high-quality illumination.



Ring

Ring is a round 'halo'-style luminaire, available in 2' to 6' diameters. Ideal for lobbies and corridors, it offers uniform illumination with a modern touch.



Lucie Curve

Lucie Curve is a backlit projection fabric luminaire ideal for creating luminous ceilings. Tunable white and custom-printed graphics are available.



Loop

Loop is a suspended architectural LED 'ring' that provides a soft, inviting glow with uplight and downlight, perfect for healthcare lobbies.



Hex

Hex features a bold hexagonal shape and contemporary design, offering high-performance lighting for various applications.



Quad

Quad blends modern aesthetics with uplight and downlight, creating a stunning geometric look and Warm dynamic lighting effects.



LS Series

Our flagship line of versatile, high-performance architectural luminaires delivers up to 135 lumens per watt with exceptional color rendering. Available with aperture sizes ranging from nominal 2" to 6", this series features high-recycled-content construction, Declare listing with Red List Free option, and a wide range of mounting, lens, glare control, and beam distribution options. Custom lengths, patterns and finishes are available.



LS1/LS2 Curve

LS Curve is a custom curved luminaire with 1.9" or 2.5" apertures. It offers custom radii and straight sections, along with various mounting options.



LS1

LS1 is a slim-profile luminaire, offering direct, indirect, or direct/indirect lighting with customizable patterns and colors.



LS2

LS2 is a slim-profile luminaire with a 2-1/2" aperture. It offers direct, indirect, or direct/indirect lighting with customizable patterns and colors.



LS3

LS3 is a linear luminaire with a 3" aperture. It offers direct, indirect, or direct/indirect lighting with customizable patterns and colors.



LS4

LS4 is a linear luminaire with a 3-7/8" aperture. It features flush or regressed lenses and offers direct, indirect, or direct/indirect lighting.



LS6

LS6 is a linear luminaire with a 6" aperture. It offers direct, indirect, or direct/indirect lighting with customizable patterns and colors.

LSR2

Part of our LS Series of architectural luminaires, the LSR2 is a Declare Listed recessed linear luminaire with a 2-1/2" aperture and optional 1" regressed lens for additional glare control. Custom lengths, welded patterns, and finishes are available.

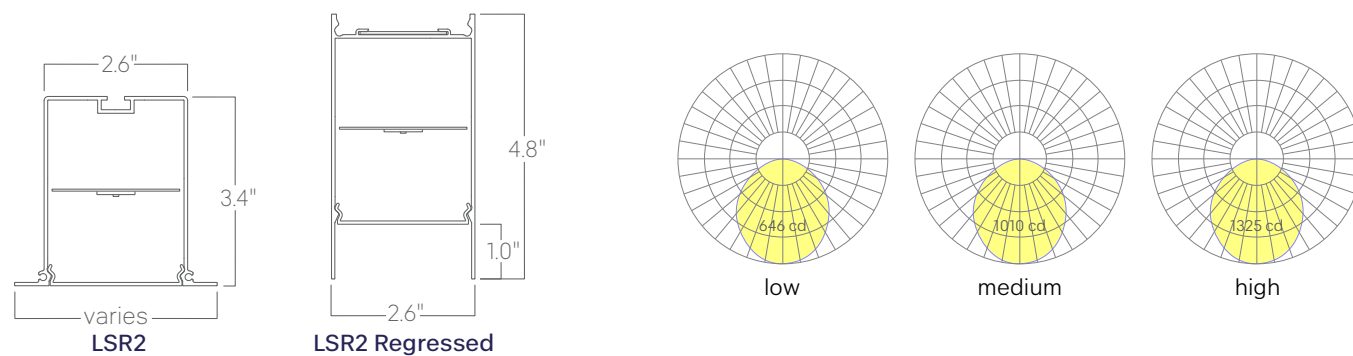

- Tuneable White
- Warm Dim
- Power Over Ethernet
- Declare Listed
- CRI > 90 R9 > 70
- Low Glare



Architectural Troffers

Coronet's architectural troffers feature sleek designs, low glare, and energy efficiency. Ideal for various applications, these fixtures provide uniform illumination that enhances visibility and creates a comfortable atmosphere. Available in multiple configurations, they seamlessly integrate into any healthcare space.

KSR1

KSR1 is a shallow, center-basket architectural troffer featuring a formed acrylic lens, available in 2'x2' or 2'x4' sizes. The lens enhances light diffusion for even distribution, minimizing harsh shadows and improving visibility. Its durable construction ensures long-lasting performance in any setting.

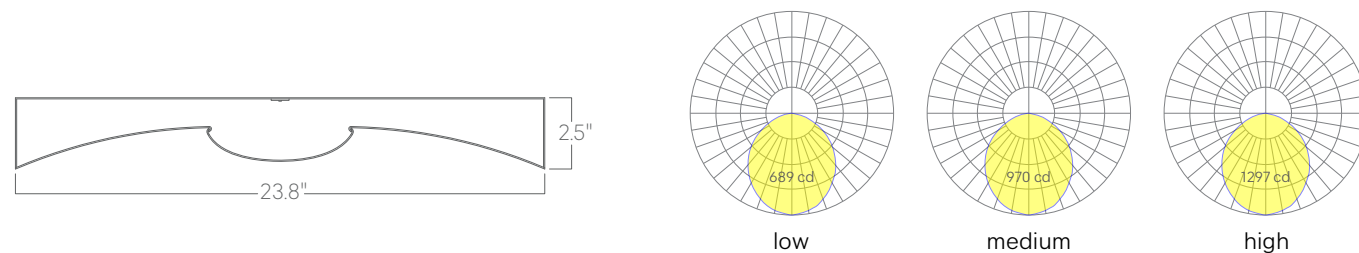

- Tuneable White
- Power Over Ethernet
- CRI > 90
R9 > 50
- Low Glare



KSR1

KSR1 is a shallow 2.5" deep, center-basket troffer with a formed acrylic lens, available in 2'x2' or 2'x4' sizes. It offers even light distribution and durability.



TDCW

TDCW is a recessed, high-performance direct/indirect luminaire with a perforated metal shield, offering soft, low-glare lighting. Available in 1'x4', 2'x2', or 2'x4' sizes.



TDMX

TDMX is a recessed luminaire with direct/indirect lighting and dual frosted diffusers. It fits obstructed ceiling plenums and is available in 2'x2' & 2'x4' sizes.



TDSW

TDSW is a recessed, direct/indirect luminaire with a perforated metal lamp shield. Ideal for soft, low glare lighting, available in 2'x2' or 2'x4' sizes.



TSSW

TSSW is a low-profile architectural luminaire with a formed acrylic lens. Its shallow design fits obstructed ceiling plenums. Available in 2'x2' & 2'x4' sizes.

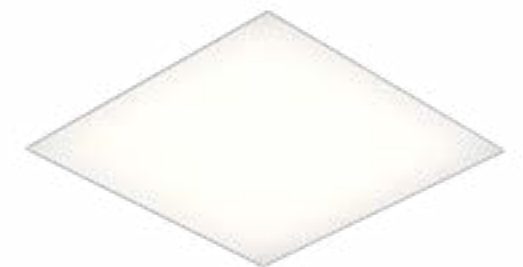

Wet

Wet is a recessed luminaire available in 1'x4', 2'x2', and 2'x4' sizes. Gasketed, available with Tuneable White and listed for Wet locations..

CORRIDORS

In hospital hallways and corridors, lighting plays a crucial role in both functionality and aesthetics. With Coronet's solutions, these spaces transform from simple pathways into well-lit corridors that guide patients and visitors with ease, creating a comforting and efficient healthcare environment. Our innovative lighting not only ensures safety and visibility but also elevates the overall experience for both patients and staff.





Cove & Perimeter

Coronet's cove and perimeter lighting solutions seamlessly integrate into healthcare settings, providing subtle, indirect illumination that enhances ambiance. With customizable lengths and flexible installation options, these fixtures create inviting atmospheres and accentuate architectural features, ensuring a warm and welcoming environment.

PF4 Fill

The PF4 Perimeter Fill elegantly washes corridors with light from the perimeter, making it perfect for hallways or spaces where fixtures should remain discreet. It delivers high levels of illumination while ensuring seamless integration into the environment, enhancing visibility without compromising aesthetics.

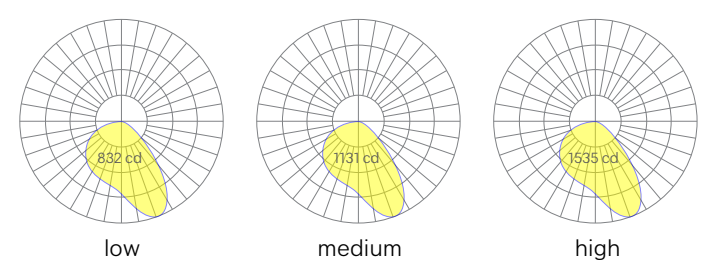
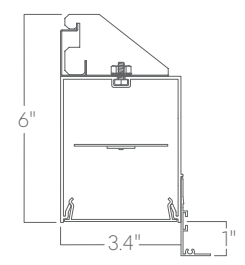

- Tunable White
- Warm Dim
- Power Over Ethernet
- CRI > 90
R9 > 50
- Low Glare



PF Fill

PF Fill luminaires regress into ceiling edges and asymmetrically cast light into the room. Available in custom lengths and patterns to enhance any modern environment.



Easy Cove Easy Perimeter

Easy Cove is an easy-install luminaire available in a ceiling version with a WAO for extended ceiling projection and a wall version for perimeter lighting.



Flawless

Flawless wall grazer luminaires feature a 15° optic for optimal grazing. Depth of regress is specifiable for subtle, even vertical illumination.



PG Series

PG Series perimeter luminaires regress into ceilings, providing subtle, even vertical illumination. Available with specifiable 1", 2", 3", or 4" regress.



LS Series

Our flagship line of versatile, high-performance architectural luminaires delivers up to 135 lumens per watt with exceptional color rendering. Available with aperture sizes ranging from nominal 2" to 6", this series features high-recycled-content construction, Declare listing with Red List Free option, and a wide range of mounting, lens, glare control, and beam distribution options. Custom lengths, patterns and finishes are available.



LS1/LS2 Curve

LS Curve is a custom curved luminaire with 1.9" or 2.5" apertures. It offers custom radii and straight sections, along with various mounting options.



LS1

LS1 is a slim-profile luminaire, offering direct, indirect, or direct/indirect lighting with customizable patterns and colors.



LS2

LS2 is a slim-profile luminaire with a 2-1/2" aperture. It offers direct, indirect, or direct/indirect lighting with customizable patterns and colors.



LS3

LS3 is a linear luminaire with a 3" aperture. It offers direct, indirect, or direct/indirect lighting with customizable patterns and colors.



LS4

LS4 is a linear luminaire with a 3-7/8" aperture. It features flush or recessed lenses and offers direct, indirect, or direct/indirect lighting.



LS6

LS6 is a linear luminaire with a 6" aperture. It offers direct, indirect, or direct/indirect lighting with Warm customizable patterns and colors.

LSR4

Part of our LS Series, the LSR4 is a Declare Listed recessed linear luminaire with a 3-7/8" aperture. It offers low-glare direct lighting with customizable lengths, welded patterns, and finishes. Features integral dimmable drivers or PoE options.

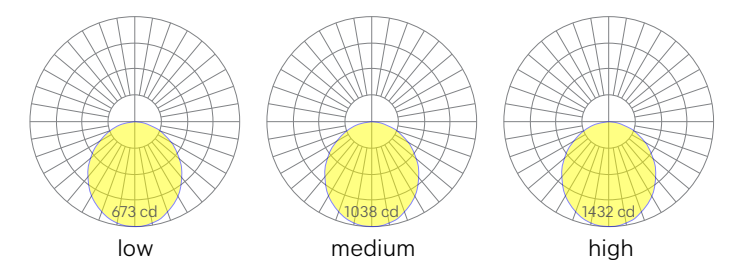
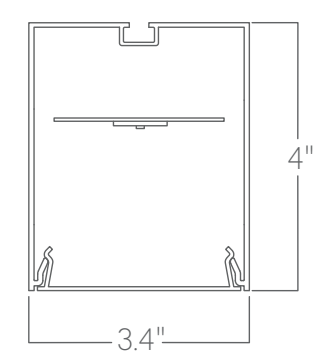

- Power
Over
Ethernet
- Declare
Listed
- CRI > 90
R9 > 70
- Low
Glare



Architectural Troffers

Coronet's architectural troffers feature sleek designs, low glare, and energy efficiency. Ideal for various applications, these fixtures provide uniform illumination that enhances visibility and creates a comfortable atmosphere. Available in multiple configurations, they seamlessly integrate into any healthcare space.



KSR1

KSR1 is a shallow, center-basket troffer with a formed acrylic lens, available in 2'x2' or 2'x4' sizes. It offers even light distribution and durability.



TDCW

TDCW is a recessed, high-performance direct/indirect luminaire with a perforated metal shield, offering soft, low-glare lighting. Available in 1'x4', 2'x2', or 2'x4' sizes.



TDMX

TDMX is a recessed luminaire with direct/indirect lighting and dual frosted diffusers. It fits obstructed ceiling plenums and is available in 2'x2' & 2'x4' sizes.



TDSW

TDSW is a recessed, direct/indirect luminaire with a perforated metal lamp shield. Ideal for soft, low glare lighting, available in 2'x2' or 2'x4' sizes.



TSSW

TSSW is a low-profile architectural luminaire with a formed acrylic lens. Its shallow design fits obstructed ceiling plenums. Available in 2'x2' & 2'x4' sizes.

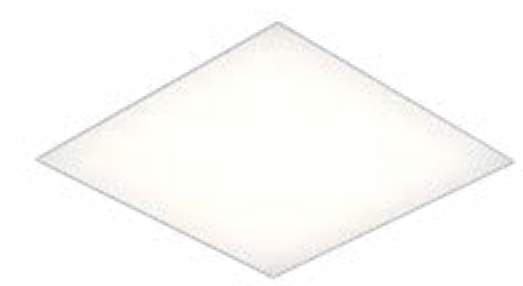

Wet

Wet is a recessed luminaire with a prismatic lens available in 1'x4', 2'x2', and 2'x4' sizes. Gasketed Tuneable and listed for Wet locations..

TDMX

TDMX is a recessed luminaire offering direct/indirect lighting with dual frosted diffusers for soft, low-glare illumination. Available in 2'x2' and 2'x4' sizes, it fits obstructed ceiling plenums for versatile applications. Compatible with 0-10V wall dimmers, its shallow design allows for easy installation in tight spaces.

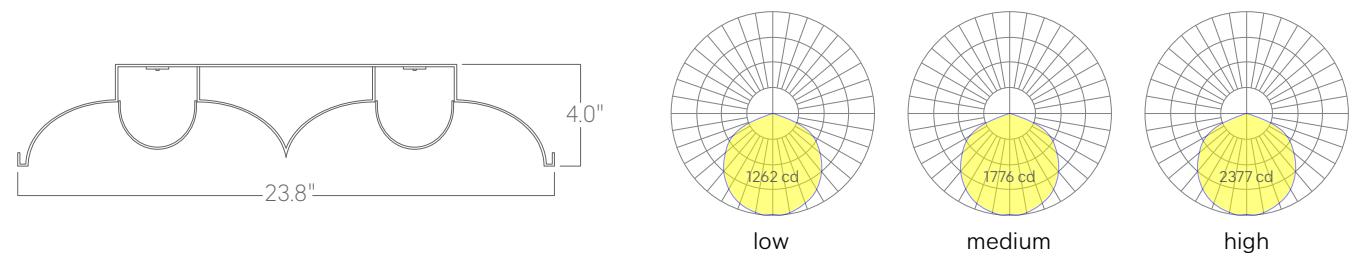

- Tuneable White
- Warm Dim
- Power Over Ethernet
- CRI > 90
R9 > 50
- Low Glare



Geometric Series

Our Geometric Series Lighting features a striking collection of fixtures in circles, squares, and rectangular shapes, designed to elevate any space with modern elegance. Each fixture boasts clean lines and a minimalist aesthetic, making them ideal for healthcare settings. Available in various sizes and finishes, these versatile lights create dynamic visual interest while providing optimal illumination.



PRD/RRD

RRD is the recessed version of the suspended PRD, featuring architectural round luminaires with a concave lens for high-quality illumination.



Ring

Ring is a round 'halo'-style luminaire, available in 2' to 6' diameters. Ideal for lobbies and corridors, it offers uniform illumination with a modern touch.



Lucie Curve

Lucie Curve is a backlit projection fabric luminaire ideal for creating luminous ceilings. Tunable white and custom printed graphics available.



Loop

Loop is a suspended architectural LED 'ring' that provides a soft, inviting glow with uplight and downlight, perfect for healthcare lobbies.



Hex

Hex features a bold hexagonal shape and contemporary design, offering high-performance lighting for various applications.



Quad

Quad blends modern aesthetics with uplight and downlight, creating a stunning geometric look and Warm dynamic lighting effects.

Lucie Curve

The Lucie Curve backlit projection fabric luminaire is ideal for creating stunning luminous ceiling clouds. Available in standard or custom sizes, it offers tunable white light to adjust ambiance and custom printed graphics for unique designs. Perfect for transforming modern spaces into captivating environments.

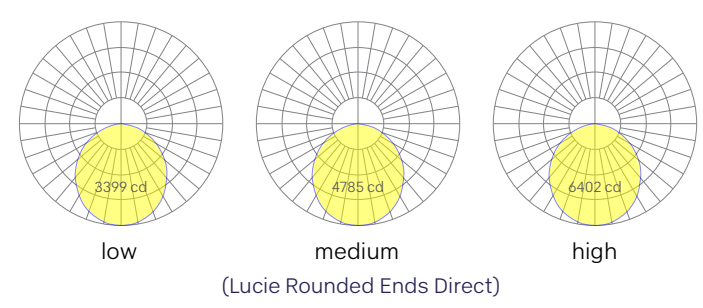
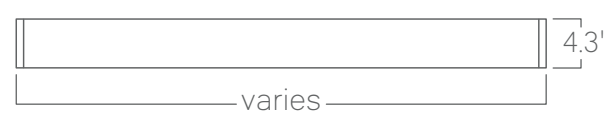

- Tuneable White
- Warm Dim
- Power Over Ethernet
- Declare Listed
- CRI > 90
R9 > 50
- Low Glare



AMENITY SPACES

In hospital common areas such as lobbies and waiting rooms, wellness areas within hospitals—ranging from serene relaxation rooms to state-of-the-art fitness centers—lighting is crucial for creating a holistic environment that promotes relaxation and recovery.

Coronet offers a diverse range of lighting solutions tailored for these settings. Our low-glare fixtures deliver optimal illumination without discomfort, ensuring every space is inviting and conducive to well-being. With our solutions, wellness areas become havens of tranquility, fostering healing and rejuvenation for patients, visitors, and healthcare providers alike.

Performace Decorative

Coronet's performance decorative fixtures are perfect for healthcare amenity spaces. Our collection blends elegant design in various scales with exceptional lighting quality, enhancing both aesthetics and functionality. Each fixture is crafted for reliability and efficiency, making them ideal for contemporary healthcare environments.



Drop Series

The Drop monopoint series combines striking design with function, offering customizable lighting and versatile mounting options.



Orb Recessed

Orb Recessed is a simple, 4" diameter, semi-recessed orb of light that seamlessly integrates into ceilings or walls. Its minimalist design provides a soft, inviting glow.



Loopita

Loopita is a power-over-wire, halo-style luminaire with a shallow profile, offering elegant uplight and downlight. It's available in diameters up to 48" and comes in custom colors.



Hoop

Hoop is a decorative ring luminaire offering smooth, glare-free indirect/direct illumination from upper and lower lensless apertures. Up to 48" diameter.



Dona

Dona is a performance decorative luminaire that emits beautiful uplight and downlight, available in diameters from 2' to 6'.

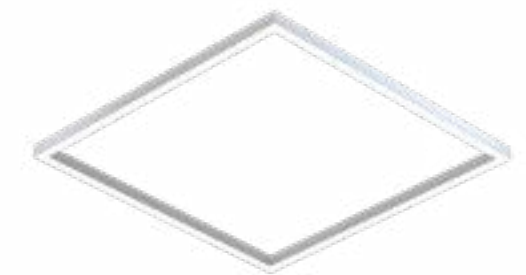

Square

Square is a pendant luminaire with a compact profile and lenses that direct light inward or downward, available in sizes from 2'x2' to 4'x4'.

Drop Series

Our Drop cylinders blend functionality with stunning design. Available in various sizes and finishes, these durable recycled aluminum fixtures offer customizable beam spreads and excellent color rendering. The Drop Narrow 2.5 and Drop Wide 4.0 models include optional uplighting.

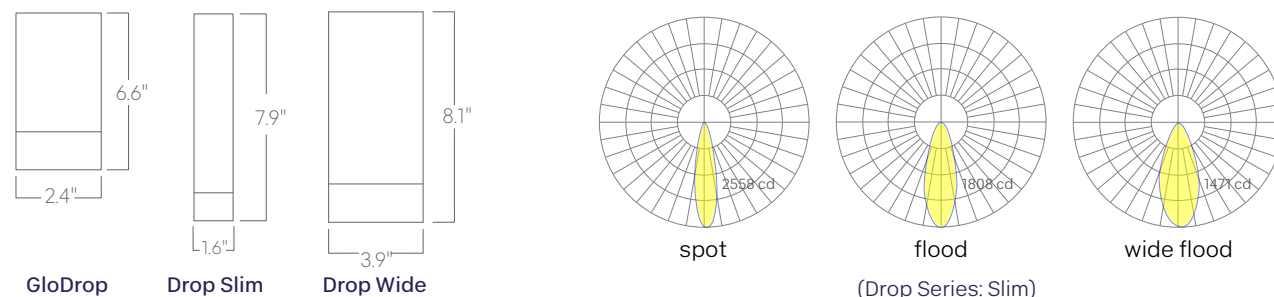



LS1/LS2 Curve

The LS1 and LS2 Curve are Declare Listed, custom curved architectural luminaires designed for versatility. The LS1 Curve has a 1.9" aperture, while the LS2 Curve features a 2.5" aperture. Both support specifiable patterns, including custom radii and straight sections, and can be mounted via aircraft cable, surface, or stem.

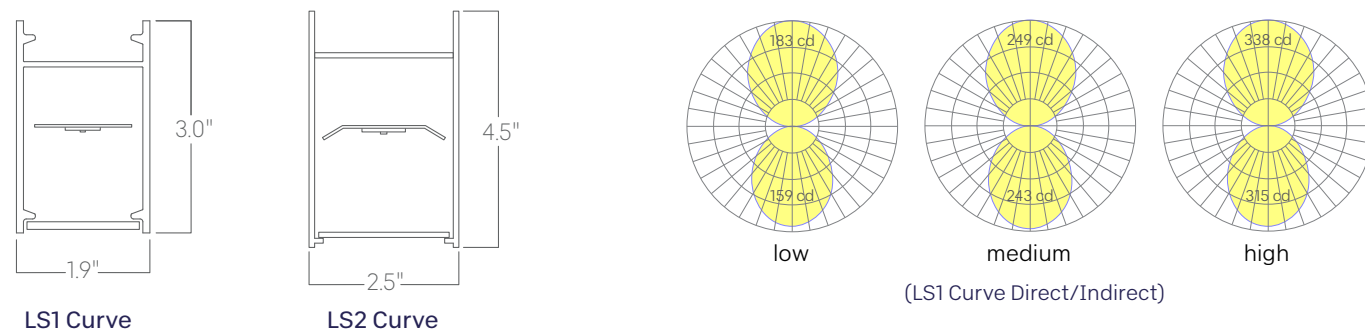

- Power
Over
Ethernet
- Declare
Listed
- CRI > 90
R9 > 70
- Low
Glare

LS Series

Our flagship line of versatile, high-performance architectural luminaires delivers up to 135 lumens per watt with exceptional color rendering. Available with aperture sizes ranging from nominal 2" to 6", this series features high-recycled-content construction, Declare listing with Red List Free option, and a wide range of mounting, lens, glare control, and beam distribution options. Custom lengths, patterns and finishes are available.



LS1/LS2 Curve

LS Curve is a custom curved luminaire with 1.9" or 2.5" apertures. It offers custom radii and straight sections, along with various mounting options.



LS1

LS1 is a slim-profile luminaire, offering direct, indirect, or direct/indirect lighting with customizable patterns and colors.



LS2

LS2 is a slim-profile luminaire with a 2-1/2" aperture. It offers direct, indirect, or direct/indirect lighting with customizable patterns and colors.



LS3

LS3 is a linear luminaire with a 3" aperture. It offers direct, indirect, or direct/indirect lighting with customizable patterns and colors.



LS4

LS4 is a linear luminaire with a 3-7/8" aperture. It features flush or recessed lenses and offers direct, indirect, or direct/indirect lighting.



LS6

LS6 is a linear luminaire with a 6" aperture. It offers direct, indirect, or direct/indirect lighting with Warm customizable patterns and colors.



Cove & Perimeter

Coronet's cove and perimeter lighting solutions seamlessly integrate into healthcare settings, providing subtle, indirect illumination that enhances ambiance. With customizable lengths and flexible installation options, these fixtures create inviting atmospheres and accentuate architectural features, ensuring a warm and welcoming environment.



PF Fill

PF Fill luminaires regress into ceiling edges and asymmetrically cast light into the room. Available in custom lengths and patterns to enhance any modern environment.



Easy Cove Easy Perimeter

Easy Cove is an easy-install luminaire available in a ceiling version with a WAO for extended ceiling projection and a wall version for perimeter lighting.

Flawless

Flawless wall grazer luminaires are engineered with a 15° optic for optimal grazing performance. Recessed into ceiling edges, they provide subtle, even vertical illumination. Specifiable 1", 2", 3", or 4" regressed lens.

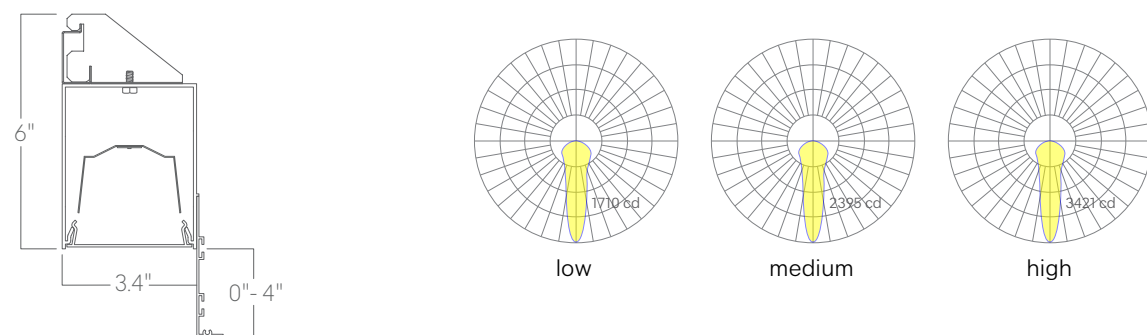

Flawless

Flawless wall grazer luminaires feature a 15° optic for optimal grazing. Depth of regress is specifiable for subtle, even vertical illumination.



PG Series

PG Series perimeter luminaires regress into ceilings, providing subtle, even vertical illumination. Available with specifiable 1", 2", 3", or 4" regress.

Architectural Troffers

Coronet's architectural troffers feature sleek designs, low glare, and energy efficiency. Ideal for various applications, these fixtures provide uniform illumination that enhances visibility and creates a comfortable atmosphere. Available in multiple configurations, they seamlessly integrate into any healthcare space.



TDJA

TDJA is a high-performance recessed troffer designed for versatile installations. Available in 1'x4', 2'x2', and 2'x4' sizes, it fits seamlessly into grid or hard ceilings. Its sleek design and durable construction ensure long-lasting performance, making it a reliable choice.

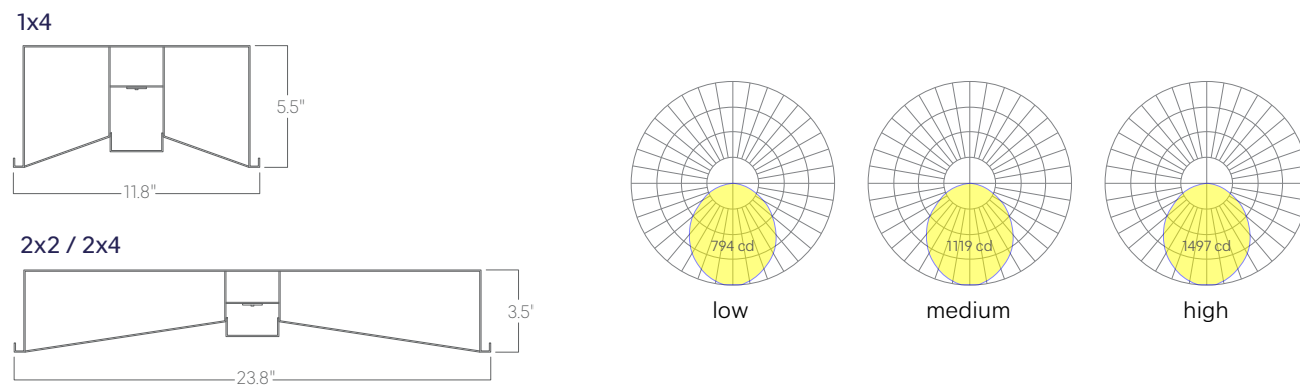

- Tuneable White
- Warm Dim
- Power Over Ethernet
- CRI > 90
R9 > 50
- Low Glare



KSR1

KSR1 is a shallow, center-basket troffer with a formed acrylic lens, available in 2'x2' or 2'x4' sizes. It offers even light distribution and durability.



TDCW

TDCW is a recessed, high-performance direct/indirect luminaire with a perforated metal shield, offering soft, low-glare lighting. Available in 1'x4', 2'x2', or 2'x4' sizes.



TDJA

TDJA is a high-performance recessed troffer in 1'x4', 2'x2', and 2'x4' sizes, fitting seamlessly into grid or hard ceilings.



TDSW

TDSW is a recessed, direct/indirect luminaire with a perforated metal lamp shield. Ideal for soft, low glare lighting, available in 2'x2' or 2'x4' sizes.



TSSW

TSSW is a low-profile architectural luminaire with a formed acrylic lens. Its shallow design fits obstructed ceiling plenums. Available in 2'x2' & 2'x4' sizes.

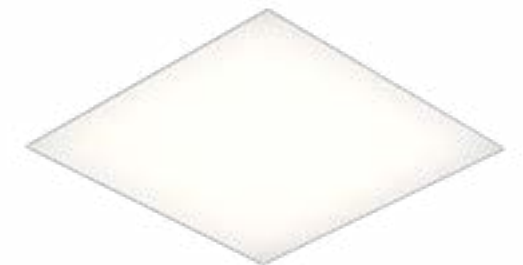

Wet

Wet is a recessed luminaire with a prismatic lens available in 1'x4', 2'x2', and 2'x4' sizes. Gasketed Tuneable and listed for Wet locations..



PATIENT ROOMS

In patient rooms, effective lighting is essential for both comfort and functionality. Coronet's thoughtfully designed lighting solutions enhance caregiver effectiveness while promoting patient well-being. Features like patient control integrations and a natural 24-hour light sequence create calming environments that prioritize sleep quality and overall comfort.

Our task lighting solutions ensure that healthcare providers can perform critical tasks accurately while maintaining a tranquil atmosphere. We also prioritize ease of cleaning in our fixture designs, reducing infection risks through accessible maintenance. With diverse lighting modes—softer tones for relaxation and brighter tones for active tasks—we improve the overall experience for patients and staff, ultimately benefiting outcomes and efficiency.



LS Series

Our flagship line of versatile, high-performance architectural luminaires delivers up to 135 lumens per watt with exceptional color rendering. Available with aperture sizes ranging from nominal 2" to 6", this series features high-recycled-content construction, Declare listing with Red List Free option, and a wide range of mounting, lens, glare control, and beam distribution options. Custom lengths, patterns and finishes are available.



LS1

LS1 is a slim-profile luminaire, offering direct, indirect, or direct/indirect lighting with customizable patterns and colors.



LS2

LS2 is a slim-profile luminaire with a 2-1/2" aperture. It offers direct, indirect, or direct/indirect lighting with customizable patterns and colors.



LS2DL

LS2 Downlight is a modular linear system with customizable placement in fixed, adjustable, and wall wash forms, offering various beam spreads.



LS3

LS3 is a linear luminaire with a 3" aperture. It offers direct, indirect, or direct/indirect lighting with customizable patterns and colors.



LS4

LS4 is a linear luminaire with a 3-7/8" aperture. It features flush or recessed lenses and offers direct, indirect, or direct/indirect lighting.



LS6

LS6 is a linear luminaire with a 6" aperture. It offers direct, indirect, or direct/indirect lighting with Warm customizable patterns and colors.

LS2DL

The LS2 Downlight is a versatile system incorporating specifiable linear components and downlight modules. Downlights are available as 360° aimable, fixed-position, or wall-wash. Independent linear and downlight control enable use as task lighting, ambient lighting, or both.

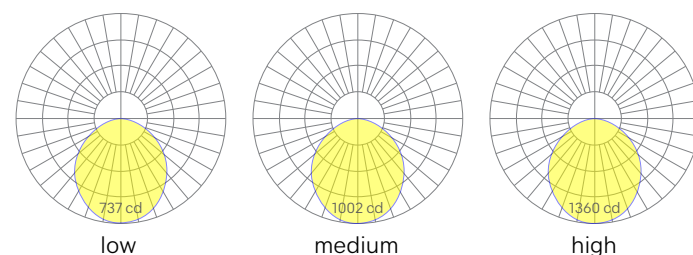
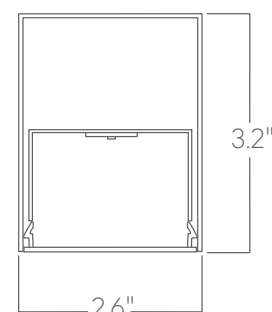

- Tuneable White
- Warm Dim
- Power Over Ethernet
- Declare Listed
- CRI > 90 R9 > 70
- Low Glare



Linear Luminaires

Coronet's architectural linear lighting products offer essential illumination solutions ideal for patient rooms. Our versatile fixtures integrate seamlessly into ceilings and walls, delivering even, glare-free light that promotes comfort and well-being. Engineered for energy efficiency and durability, each fixture enhances aesthetics while meeting high-performance demands.



Ray 4 Recessed

Ray4 is a sleek, recessed linear luminaire with a 3.4" beveled recycled aluminum extrusion, offering direct lighting and customizable designs.



Ray 6 Recessed

Ray6 is a sleek, recessed linear luminaire with a 5.4" beveled recycled aluminum extrusion, offering direct lighting options and customizable designs.



Slick Recessed

Slick Recessed is a linear lighting system featuring optional modular downlights with three beam spread options. Custom lengths and patterns available.



Gem Recessed

Gem Recessed is a linear luminaire with a diamond shaped profile, perfect for vertical wall corners. Its available in surface and wall-to-ceiling options.



Rush Sharp Recessed

Rush Sharp Recessed is a low-profile luminaire with specially designed optic cells for beam control and best possible glare reduction. Custom outputs and colors available.



Reveal Recessed

Reveal Recessed features a shallow 1" depth and room-side snap-in installation. This 3" lensed aperture Warm luminaire is ideal for limited-access applications.

Ray 4

Ray4 is a linear architectural luminaire with a 1" regressed lens for exceptional glare reduction. It offers recessed, surface-mount, and suspended mounting options, making it versatile for various applications. Custom patterns, colors, and elevations are available to suit specific needs.

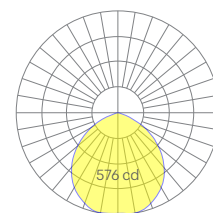
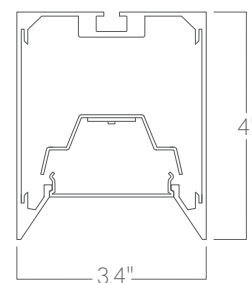

low

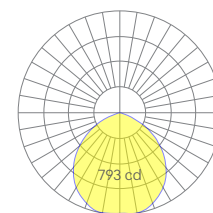

medium

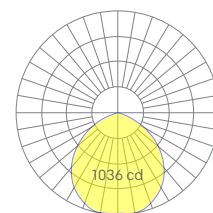

high

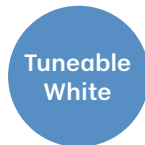



Architectural Troffers

Coronet's architectural troffers feature sleek designs, low glare, and energy efficiency. Ideal for various applications, these fixtures provide uniform illumination that enhances visibility and creates a comfortable atmosphere. Available in multiple configurations, they seamlessly integrate into any healthcare space.

TSSW

TSSW is a low-profile architectural luminaire with a formed acrylic lens for excellent light diffusion and a sleek appearance. Its shallow design fits obstructed ceiling plenums, making it ideal for spaces with limited vertical clearance. Available in 2'x2' and 2'x4' sizes.

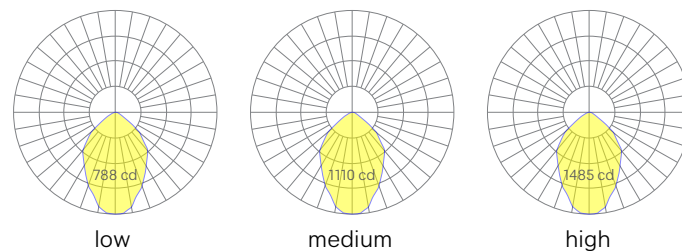
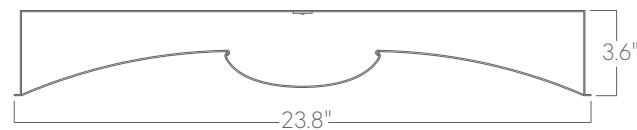

- Tuneable White
- Warm Dim
- Power Over Ethernet
- CRI > 90
R9 > 50
- Low Glare



KSR1

KSR1 is a shallow, center-basket troffer with a formed acrylic lens, available in 2'x2' or 2'x4' sizes. It offers even light distribution and durability.



TDCW

TDCW is a recessed, high-performance direct/indirect luminaire with a perforated metal shield, offering soft, low-glare lighting. Available in 1'x4', 2'x2', or 2'x4' sizes.



TDMX

TDMX is a recessed luminaire with direct/indirect lighting and dual frosted diffusers. It fits obstructed ceiling plenums and is available in 2'x2' & 2'x4' sizes.



TDSW

TDSW is a recessed, direct/indirect luminaire with a perforated metal lamp shield. Ideal for soft, low glare lighting, available in 2'x2' or 2'x4' sizes.



TSSW

TSSW is a low-profile architectural luminaire with a formed acrylic lens. Its shallow design fits obstructed ceiling plenums. Available in 2'x2' & 2'x4' sizes.

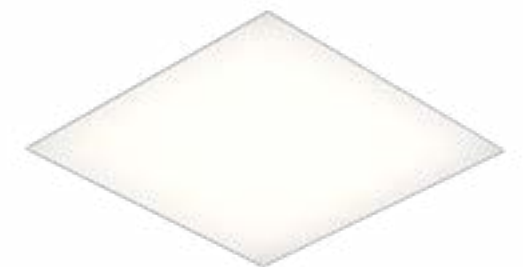

Wet

Wet is a recessed luminaire with a prismatic lens available in 1'x4', 2'x2', and 2'x4' sizes. Gasketed Tuneable and listed for Wet locations..



Cove & Perimeter

Coronet's cove and perimeter lighting solutions seamlessly integrate into healthcare settings, providing subtle, indirect illumination that enhances ambiance. With customizable lengths and flexible installation options, these fixtures create inviting atmospheres and accentuate architectural features, ensuring a warm and welcoming environment.



PF Fill

PF Fill luminaires regress into ceiling edges and asymmetrically cast light into the room. Available in custom lengths and patterns to enhance any modern environment.



Easy Cove Easy Perimeter

Easy Cove is an easy-install luminaire available in a ceiling version with a WAO for extended ceiling projection and a wall version for perimeter lighting.

PG2

The PG2 perimeter LED lighting system offers a sleek solution for modern interiors. Its recessed design features specifiable depths of 1", 2", 3", or 4", allowing for a seamless and unobtrusive installation. This system delivers subtle, even vertical illumination, while custom lengths and patterns can be tailored to fit any space.

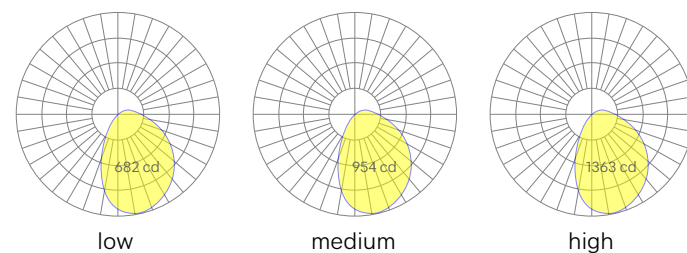
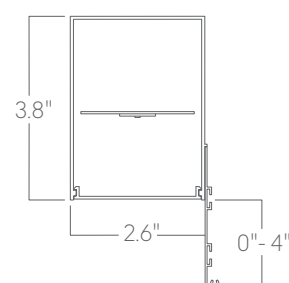

- Tunable White
- Warm Dim
- Power Over Ethernet
- CRI > 90
R9 > 50
- Low Glare



Flawless

Flawless wall grazer luminaires feature a 15° optic for optimal grazing. Depth of regress is specifiable for subtle, even vertical illumination.



PG Series

PG Series perimeter luminaires regress into ceilings, providing subtle, even vertical illumination. Available with specifiable 1", 2", 3", or 4" regress.



Illuminate Brilliantly.



55 Shepherds Lane, Totowa, NJ 07512 | +1 973.345.7660 | info@coronetled.com | coronetled.com

© 2026 Coronet LED. All Rights Reserved.