

CRD1 Sconce Double



A unique tube luminaire that is flexible featuring a sconce wall mount and is suitable for any modern space.

Features

- Extruded aluminum housing
- Components rotate 360° for direct or indirect lighting
- Aluminum core LED boards
- Specifiable color temperature. CRI > 90, R9 > 50
- 5 Year, 50,000 hour warranty, damp location rated
- WELL Building Standard compatible [learn more](#)

Dimensions

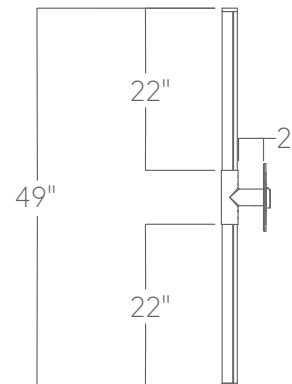

Optics

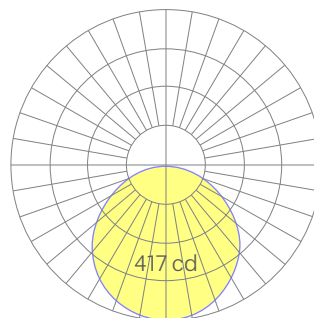

medium

Representative distribution and peak candela. For other options see order information or IES files [here](#).

CRD1 Sconce Double

Ordering Information

For each option group below specify one option. If you don't see your preferred option listed, contact us for [help](#).

1	Fixture ID	2	Length	3	Color Temperature	4	Output
	CRDISC.DB	4	4ft sconce	27 30 35	2700K/90 CRI 3000K/90 CRI 3500K/90 CRI	MED	Medium output
5	Voltage	6	Driver	7	Finish	8	Mounting
	UNV Universal (120/277V)	DR96	96W Driver, 0-10v dimming <small>Linear Dimming Curve by default. Consult factory for Logarithmic options.</small>	BLK RB PW GOLD W	Black Rose Brass Pewter Gold White	SC	Sconce Mount
9	Optics	10	Sensors/Controls	11	Circuit	12	Options
	SD Standard Diffuser	NA None ACM Acuity nLight Module Only ACAM Acuity nLight Air (r10) CCS Casambi Module AWNDR Lutron Athena Wireless Node Module OTHER Consult Factory <small>All controls remote.</small>		NA None EMPK Emergency battery pack EMCKT Emergency circuit <small>May require additional power feeds</small>		NA None	

Performance

Output ¹	Watts	Lumens
Medium	24	1600

¹Based on a typically configured 90 CRI, 3500K luminaire using one driver with a total length of 4ft.

Technical Information



click [here](#) or scan QR code

Wiring diagrams, PoE and sensor details

CRD1 Sconce Double

Drivers & Electrical

Constant voltage, 0-10V dimmable drivers are supplied in remote enclosures.

For remote driver box sizes, click [here](#).

Emergency Back-Up

A 6W emergency driver may be wired to 4ft linear modules only and will be fixed in place. A 10W driver is available. All emergency battery packs are remote. Emergency circuits for use with building generators are also available.

Weight

1.5 lbs per foot (excludes spots)

Optics

Extruded satin acrylic lenses provide excellent diffusion, high transmission, and no LED imaging.

Construction

Extruded aluminum housing.

Finishes

All luminaires are finished in high quality polyester powder coating.



Black

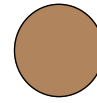

Rose Brass

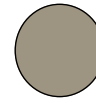

Pewter

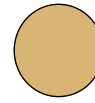

Gold

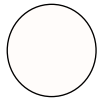

White

CRD1 Sconce Double

Mounting Options

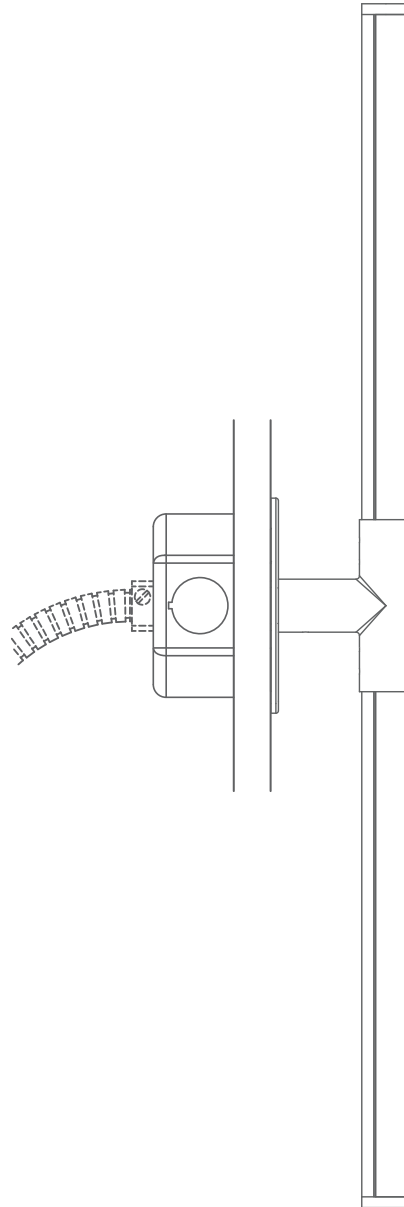

Sconce mount

To prevent damage to fixtures, factory designated mounting locations must not be field altered.
Do not attempt installation if you do not understand the installation instructions.