

# LSR3 Louver recessed



The LS Series of architectural luminaires offers a wide range of profiles and mounting options. Custom lengths and patterns are tailored to suit any modern space.

## Features

- Extruded recycled aluminum housing
- Aluminum core LED boards, specifiable optics
- Specifiable color temperature. CRI > 90, R9 > 50
- Custom lengths, welded patterns, and finishes available
- Integral specifiable dimmable drivers or PoE
- 5 Year, 50,000 hour warranty, damp location rated
- Compatible with all wood ceilings
- WELL Building Standard compatible [learn more](#)

## Dimensions

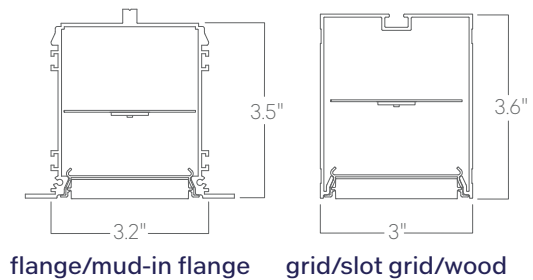

## Optics

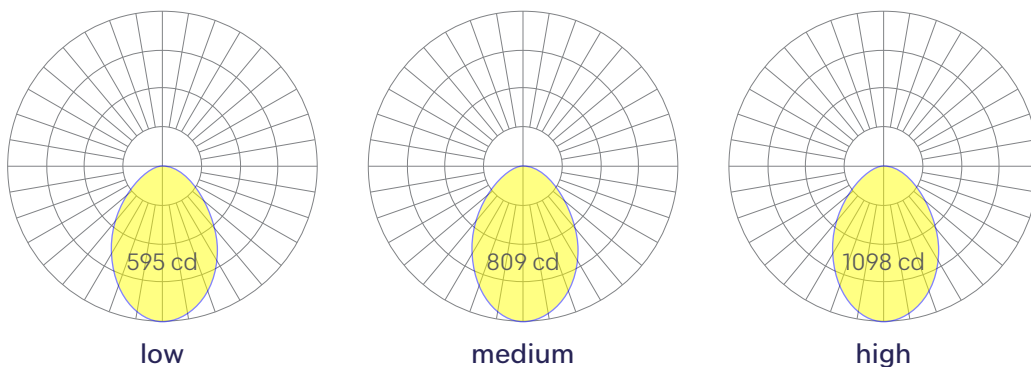

Representative distribution and peak candela. For other options see order information or IES files [here](#).

# LSR3 Louver recessed

## Ordering Information

For each option group below specify one option. If you don't see your preferred option listed, contact us for [help](#).

1 Fixture ID	2 Length	3 Color Temperature	4 Output
<b>LSR3 LVR</b>	<b>2</b> 2 ft <b>4</b> 4 ft <b>8</b> 8 ft <b>X'-X"</b> Specify Length <b>PAT</b> Pattern (Consult Factory)	<b>27</b> 2700K/90 CRI <b>30</b> 3000K/90 CRI <b>35</b> 3500K/90 CRI <b>40</b> 4000K/90 CRI <b>50</b> 5000K/90 CRI <b>WD</b> Warm Dim 2200K-3000K Must use WD10 driver <b>TW</b> Tunable White 2700K-6500K Must use TW10 driver <b>RGBW30</b> RGB +white, 3000k Remote DMX. High output unavailable. <b>RGBW35</b> RGB +white, 3500k Remote DMX. High output unavailable. <b>RGBW40</b> RGB +white, 4000k Remote DMX. High output unavailable.	<b>LOW</b> Low output <b>MED</b> Medium output <b>HIGH</b> High output <b>CUST</b> Custom output Specify watts or lumens
5 Voltage	6 Driver	7 Finish	8 Mounting
<b>UNV</b> Universal (120/277V) <b>347V</b> 347V Available for DB driver only	<b>DB</b> Standard 0-10V 1% <b>DB.1%</b> 0-10V 0.1% <b>ELV</b> Reverse Phase 1% (120V only) For compatible dimmers, click <a href="#">here</a> . <b>TRI</b> Forward phase (120V only) For compatible dimmers, click <a href="#">here</a> . <b>LDE1</b> Lutron Digital EcoSystem <b>JA8</b> JA8 compliant 1% dimming <b>DALI</b> DALI-2 Driver <b>PoE</b> Power over ethernet. <b>TW10</b> 2 ch, 0-10V for tunable white. <b>WD10</b> 0-10V Warm Dim <b>DMX</b> DMX512 All DMX drivers set to default address 001 and provided in remote enclosures. Contact us for other addressing needs.	<b>W</b> White <b>BLK</b> Black <b>SLV</b> Silver <b>CC</b> Custom Color See finish options <a href="#">here</a> . <b>CWF</b> Custom Wood Finish See finish options <a href="#">here</a> .	<b>T</b> 9/16" Tee Grid <b>T15</b> 15/16" Tee Grid <b>SG</b> Slot Grid/Interlude <b>F</b> Flange <b>NT</b> Mud-in Flange <b>PM-X</b> Perimeter Mount *X denotes mounting type on opposite side of wall (eg PM-NT). <b>WOOD</b> Wood ceiling Provide specifications.
9 Optics	10 Sensors/Controls	11 Circuit	12 Options
<b>FL</b> Flat Diffuser	<b>NA</b> None <b>EIS</b> Enlighted sensor <b>WISM</b> Wattstopper Occupancy <b>WISD</b> Wattstopper Daylight <b>ACM</b> Acuity nLight® module only <b>ACS</b> Acuity nLight® (nES 7) <b>ACA</b> Acuity nLight® AIR (rES 7) <b>CCS</b> Casambi module <b>AWNRR</b> Lutron Athena Wireless Node module <b>AWNS</b> Lutron Athena Wireless Sensor module <b>OTHER</b> Consult factory	<b>NA</b> None <b>EMPCK</b> Emergency battery pack <b>EMCKT</b> Emergency circuit May require additional power feeds. <b>DAYCKT</b> Daylight circuit May require additional power feeds.	<b>NA</b> None <b>WH</b> 6ft whips <b>CP</b> Chicago Plenum

## Performance

Output <sup>1</sup>	Watts/ft	Lumens/ft	LPW
Low	3.5	163	47
Medium	5.5	222	40
High	7.5	301	40

<sup>1</sup>Based on a typically configured 90 CRI, 3500K luminaire using one driver.  
Custom outputs available. Please consult factory.  
For 4000K multiply by 1.05; for 3000K, 0.9; for 2700K, 0.92.

## Technical Information



click [here](#) or scan QR code

Wiring diagrams, PoE and sensor details

# LSR3 Louver recessed

## Drivers & Electrical

Integral drivers\* with 0-10V Dimming standard. Several other driver options available; see ordering information.

\*DMX drivers are provided in remote enclosures.

## Sensors & Controls

Sensors are installed on an aluminum plate adjacent to the luminaire lens<sup>1</sup>. Coronet remains agnostic in our approach to sensors and control systems; our fixtures are compatible with most systems offered.

<sup>1</sup>Not applicable to indirect only models. Consult factory.

## Emergency Back-Up

For fixtures three-feet or longer, a 4W integral emergency driver may be wired to 4ft sections. 7W, 10W, and 12W drivers are also available (not all integral; consult factory). Emergency circuits for use with building generators are also available.

## PoE (Power over Ethernet)

Compatible with virtually all PoE systems including Molex Coresync, Igor, Smartengine, Platformatics, and NuLED SPICEbox.

Consult factory for systems not listed. See [here](#) for more info.

## Finishes

All luminaires are finished in high quality polyester powder coating. Our standard color is white. Any RAL color may be specified.

## Weight

5 lbs per foot

## Patterns

Featuring illuminated welded corners and angles. Consult factory for custom designs and elevations.

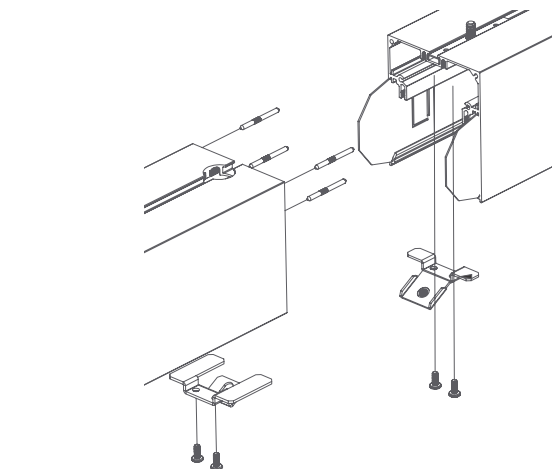
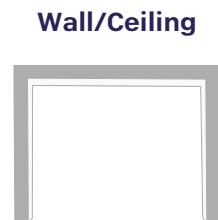
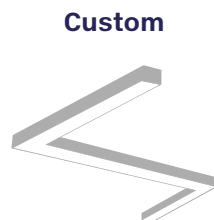
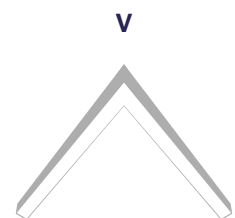
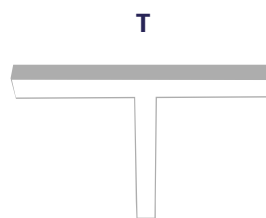
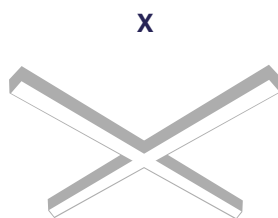
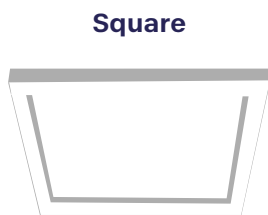

Representative joinery. For product specific details see installation guides or submittal drawings.

# LSR3 Louver recessed

## Mounting Options

Custom mounting types and ceiling transitions available; consult factory.

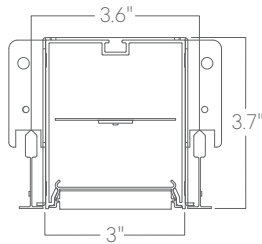

**T**  
9/16" tee grid

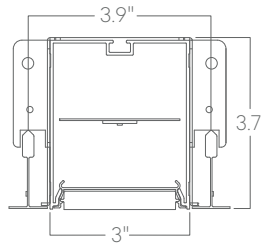

**T15**  
15/16" tee grid

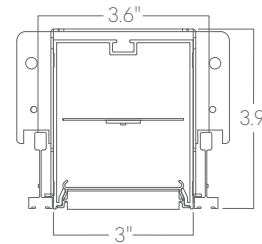

**SG**  
slot grid

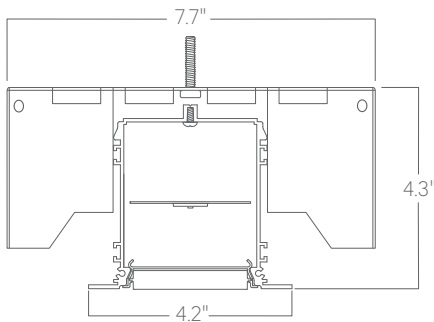

**F**  
flange

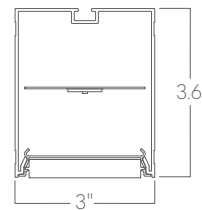

**WOOD**  
provide specifications

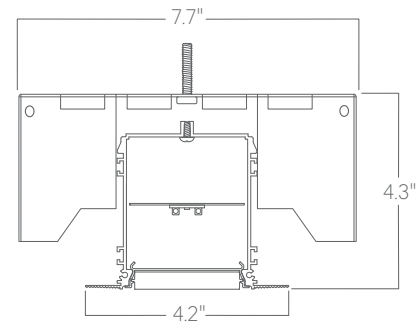

**NT**  
mud-in<sup>1</sup>

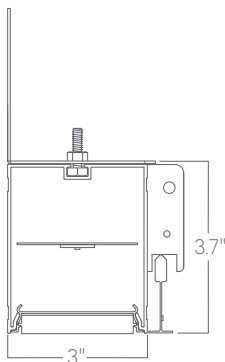

**PM-T**  
perimeter to 9/16" tee grid

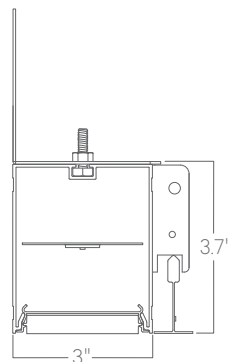

**PM-T15**  
perimeter to 15/16" tee grid

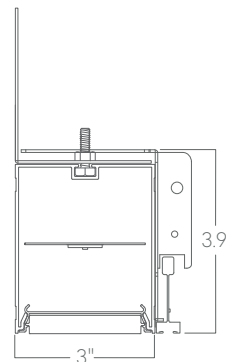

**PM-SG**  
perimeter to slot grid

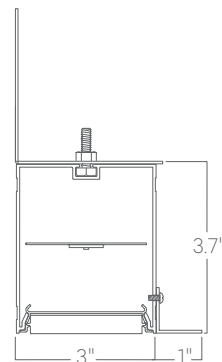

**PM-F**  
perimeter to flange

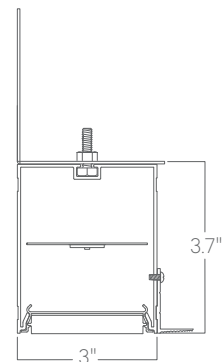

**PM-NT**  
perimeter to mud-in

<sup>1</sup>Installation that alters aperture width compromises lens security. Installer must ensure aperture width is maintained.

Please consult factory shop drawings for suspension points.

To prevent damage to fixtures, factory designated suspension points must not be field altered.

Do not attempt installation if you do not understand the installation instructions.