

# LS Wet 2.5 direct

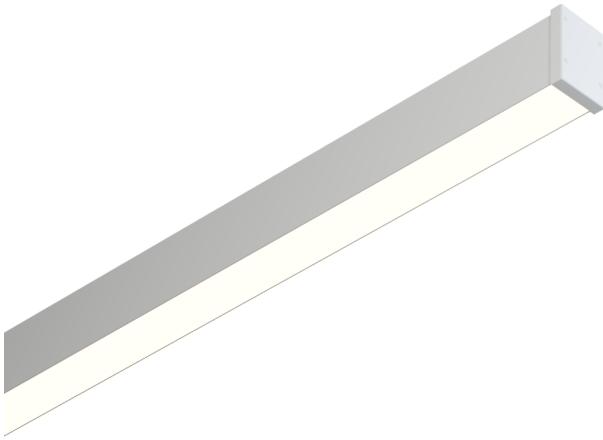

The LS Series of architectural luminaires offers a wide range of profiles and mounting options. Custom lengths are tailored to suit any modern space.

## Features

- Aluminum housing with waterproof seals and connectors
- Rated for wet locations
- Aluminum core LED boards
- Specifiable color temperature. CRI > 90, R9 >50
- Custom lengths and finishes available
- Integral specifiable dimmable drivers or PoE (remote)
- 5 Year, 50,000 hour warranty

## Dimensions

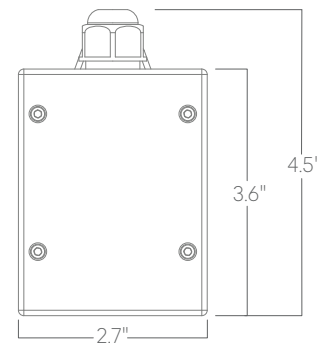

## Optics

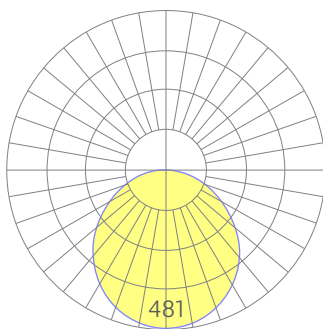

low

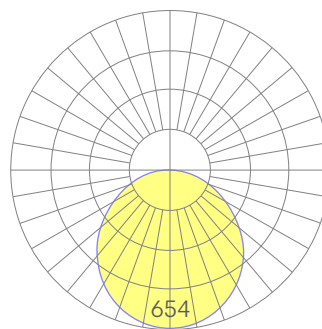

medium

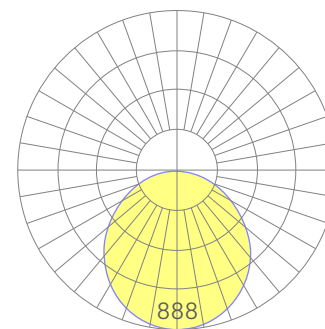

high

Representative distribution and peak candela. For other options see order information or IES files [here](#).

# LS Wet 2.5 direct

## Ordering Information



Example: LS WET 2.5 - 8 - 35 - MED - UNV - DB - W - PS - SD - CCS - EMPCK - NA

Fixture ID	1	Length	2	Color Temperature	3	Output	4
LS WET 2.5		<b>2</b> 2 ft <b>4</b> 4 ft <b>8</b> 8 ft <b>X'-X"</b> Specify Length		<b>27</b> 2700K/90 CRI <b>30</b> 3000K/90 CRI <b>35</b> 3500K/90 CRI <b>40</b> 4000K/90 CRI <b>50</b> 5000K/90 CRI  <b>WD<sup>1</sup></b> Warm Dim 2200K-3000K <b>TW<sup>2</sup></b> Tunable White 2700K-6500K <b>RGBW30<sup>3</sup></b> RGB +white, 3000k <b>RGBW35<sup>3</sup></b> RGB +white, 3500k <b>RGBW40<sup>3</sup></b> RGB +white, 4000k		<b>LOW</b> Low output <b>MED</b> Medium output <b>HIGH</b> High output <b>CUST</b> Custom output <sup>1</sup>	
		<sup>1</sup> Precision lengths may be specified to the nearest 1/8".		<sup>1</sup> Must use WD10 driver. <sup>2</sup> Must use TW10 or PSQ driver. <sup>3</sup> Must use remote DMX driver. "High" output not available.		<sup>1</sup> consult factory	
Voltage	5	Driver	6	Finish	7	Mounting	8
UNV 347V <sup>1</sup>	Universal (120/277V) 347V	<b>DB</b> Standard 0-10V 1% <b>DB.1%</b> 0-10V 0.1% <b>ELV<sup>2</sup></b> Reverse Phase 1% (120V only) <b>TRI<sup>2</sup></b> Forward phase (120V only) <b>LDE1</b> Lutron Digital EcoSystem <b>DALI</b> DALI-2 Driver <b>PoE</b> Power over ethernet. <b>TW10</b> Dual channel, 0-10V for tunable white. <b>WD10</b> 0-10V Warm Dim <b>PSQ</b> Lutron T-Series 2-channel 1% for tunable white <b>DMX<sup>1</sup></b> DMX512		<b>W</b> White <b>BLK</b> Black <b>SLV</b> Silver <b>CC<sup>1</sup></b> Custom Color		<b>AC SM</b> Aircraft Cable (50") <b>PS-X</b> Surface Mount Pendant Stem (12", 18", 24", 36", 48")	
<sup>1</sup> Must use DB Driver		<sup>1</sup> Set to default address 001. Contact us for other addressing needs. All DMX drivers provided in remote enclosures. <sup>2</sup> For compatible dimmers, click here.		<sup>1</sup> Custom Color. See finish options here.		White stems and canopy provided. Must specify other requests.	
Optics	9	Sensors/Controls	10	Circuit	11	Options	12
SD	Standard Diffuser	<b>NA</b> None <b>ACM</b> Acuity nLight Module Only <b>CCS</b> Casambi Module <b>AWNRR</b> Lutron Athena Wireless Node Module		<b>NA</b> None <b>EMPCK</b> Emergency Battery Pack <b>EMCKT</b> Emergency Circuit		<b>STD</b> White Canopy + White Cord <b>CAN-X<sup>1</sup></b> Canopy + color <b>SJ-X<sup>2</sup></b> SJ Cord + color	
		All control systems are remote. Consult factory for other options.				<sup>1</sup> See finish options here. <sup>2</sup> SJ Cord only available in White or Black.	

## Performance

Output <sup>1</sup>	Watts/ft	Lumens/ft
Low	5	328
Medium	7	446
High	10	605

<sup>1</sup>Based on a typically configured 90 CRI, 3500K luminaire using one driver.

Custom outputs available. Please consult factory.  
For 4000K multiply by 1.05; for 3000K 0.96; for 2700K, 0.92.

## Technical Information



click [here](#) or scan QR code

Wiring diagrams, PoE and sensor details

Modification date: May2023

# LS Wet 2.5 direct

## Drivers & Electrical

Integral drivers\* with 0-10V Dimming standard. Several other driver options available; see ordering information.

\*DMX drivers are provided in remote enclosures.

## Sensors & Controls

Sensors are installed remotely from the fixture. Coronet remains agnostic in our approach to sensors and control systems; our fixtures are compatible with most systems offered.

## Emergency Back-Up

For fixtures three-feet or longer, a 4W integral emergency driver may be wired to 4ft sections. 7W, 10W, and 12W drivers are also available (not all integral; consult factory). Emergency circuits for use with building generators are also available.

## PoE (Power over Ethernet)

Compatible with virtually all PoE systems including Molex Coresync, Igor, Smartengine, Platformatics, and NuLED SPICEbox. Consult Factory for systems not listed, See [here](#) for more info.

## Weight

5 lbs per foot

## Optics

Extruded satin acrylic lenses provide excellent diffusion, high transmission, and no LED imaging.

## Construction

Housings are extruded premium, recycled aluminum.

## Joined Runs

Runs of any length greater than 8 feet may be specified and are comprised of multiple, abutted, individually end-capped fixtures connected via waterproof cable connector(s).

## Finishes

All luminaires are finished in high quality polyester powder coating.

# LS Wet 2.5 direct

## Mounting Options

Custom mounting types and ceiling transitions available; consult factory.

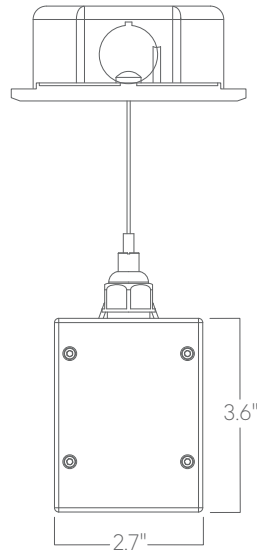

**Aircraft cable  
5" canopy**

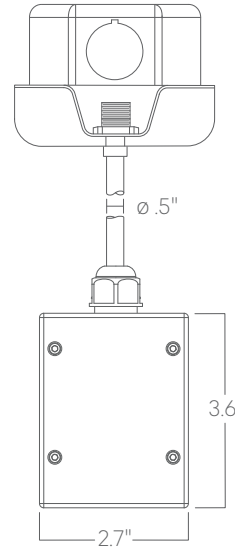

**Pendant stem**

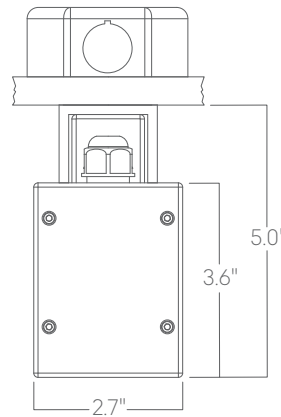

**Surface mount**