

Easy Cove wall



Our Easy Cove luminaires are designed for quick, simple installation in custom or pre-fabricated architectural coves.

Features

- Aluminum core LED boards
- Quick Connectors for continuous butt mounting
- Specifiable color temperature. CRI > 90, R9 >50
- Custom patterns and finishes available
- Integral, specifiable dimmable drivers or PoE
- 5 Year, 50,000 hour warranty, damp location rated
- WELL Building Standard compatible [learn more](#)

Dimensions

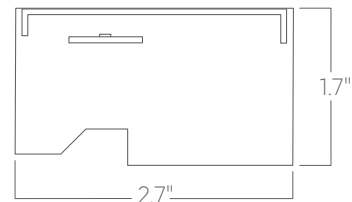

Optics

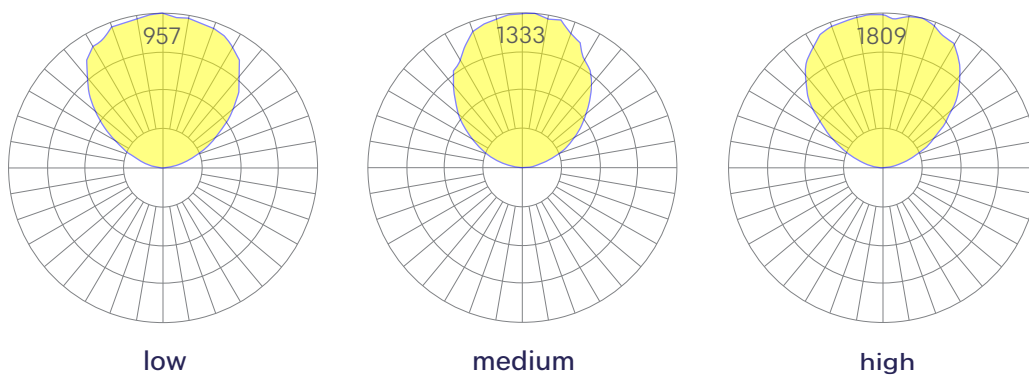

Representative distribution and peak candela. For other options see order information or IES files [here](#).

Easy Cove wall

Ordering Information



Example: EZ-W - 8 - 35 - LOW - UNV - DB - W - C - SD - CCS - DAYCKT - NA

Fixture ID <input type="text" value="1"/>	Length <input type="text" value="2"/>	Color Temperature <input type="text" value="3"/>	Output <input type="text" value="4"/>
EZ-W	2 2 ft 4 4 ft 8 8 ft X'-X" Specify Length PAT Pattern (Consult Factory)	27 2700K/90 CRI 30 3000K/90 CRI 35 3500K/90 CRI 40 4000K/90 CRI 50 5000K/90 CRI WD ¹ Warm Dim 2200K-3000K TW ² Tunable White 2700K-6500K RGBW30 ³ RGB +white, 3000k RGBW35 ³ RGB +white, 3500k RGBW40 ³ RGB +white, 4000k	LOW Low output MED Medium output HIGH High output CUST Custom output ¹
<small>¹Precision lengths may be specified to the nearest 1/8".</small>		<small>¹Must use WD10 driver. ²Must use TW10 or PSQ driver. ³Must use remote DMX driver. "High" output not available.</small>	
Voltage <input type="text" value="5"/>	Driver <input type="text" value="6"/>	Finish <input type="text" value="7"/>	Mounting <input type="text" value="8"/>
UNV 347V ¹ Universal (120/277V) 347V	DB Standard 0-10V 1% DB.1% 0-10V 0.1% ELV ² Reverse Phase 1% (120V only) TRI ² Forward phase (120V only) LDE1 Lutron Digital EcoSystem DALI DALI-2 Driver PoE Power over ethernet TW10 Dual channel, 0-10V for tunable white. WD10 0-10V Warm Dim PSQ Lutron T-Series 2-channel 1% for tunable white DMX ¹ DMX512	W White BLK Black CC ¹ Custom Color	C Cove
<small>¹Must use DB Driver</small>		<small>¹Set to default address 001. RDM capable. Contact us for other addressing needs. ²For compatible dimmers, click here.</small>	
Optics <input type="text" value="9"/>	Sensors/Controls <input type="text" value="10"/>	Circuit <input type="text" value="11"/>	Options <input type="text" value="12"/>
SD Standard Diffuser	NA None ACM Acuity nLight Module Only CCS Casambi Module AWNRR Lutron Athena Wireless Node Module	NA None EMPCK Emergency Battery Pack EMCKT Emergency Circuit DAYCKT Daylight Circuit	NA None
<small>Consult factory for other options.</small>			

Performance

Output ¹	Watts/ft	Lumens/ft
Low	5	434
Medium	7	620
High	10	868

¹Based on a typically configured 90 CRI, 3500K luminaire using one driver.

Custom outputs available. Please consult factory.
For 4000K multiply by 105, for 3000K 0.96, for 2700K, 0.92

Technical Information



click [here](#) or scan QR code

Wiring diagrams, PoE and sensor details

Modification date: September, 2022

Easy Cove wall

Drivers & Electrical

Integral drivers* with 0-10V Dimming standard. Several other driver options available; see ordering information.

*DMX drivers are provided in remote enclosures.

Controls

Control modules may be mounted within luminaires or remotely.

Emergency Back-Up

For fixtures three-feet or longer, a 4W integral emergency driver may be wired to 4ft sections. 7W, 10W, and 12W drivers are also available (not all integral; consult factory). Emergency circuits for use with building generators are also available.

PoE (Power over Ethernet)

Compatible with virtually all PoE systems including Molex Coresync, Igor, Smartengine, Platformatics, and NuLED SPICEbox. Consult Factory for systems not listed, See [here](#) for more info.

Finishes

All luminaires are finished in high quality polyester powder coating. Our standard color is white. Any RAL color may be specified.

Weight

5 lbs per foot

Patterns

Featuring illuminated welded corners and angles. Consult factory for custom designs.

Optics

Extruded satin acrylic lenses provide excellent diffusion and high transmission.

Construction

Housings are extruded premium, recycled aluminum. Individual fixtures are available up to 12' long and may be specified as nominal or precision lengths. Precision lengths are supplied within 1/8" tolerance.

Continuous Runs

Using factory supplied quick connectors, runs up to fifty feet long may be daisy-chained to a single, line-voltage-fed, starter fixture.

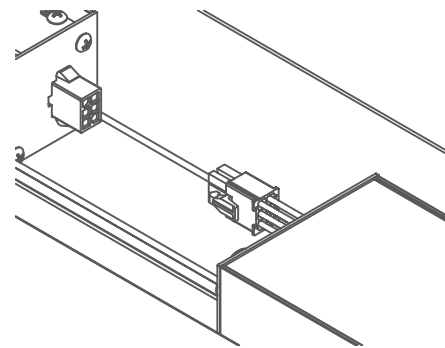

Square



V



Custom

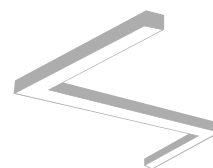

Easy Cove wall

Mounting Options

Custom mounting types and ceiling transitions available; consult factory.

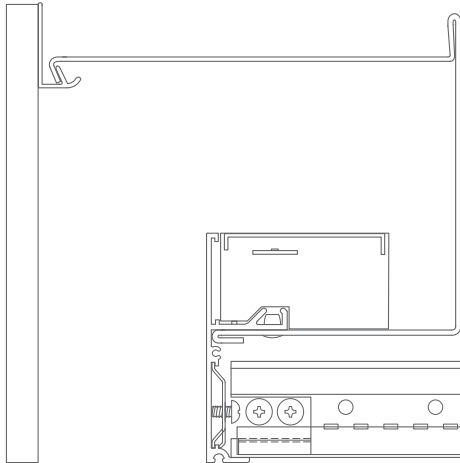

Cove

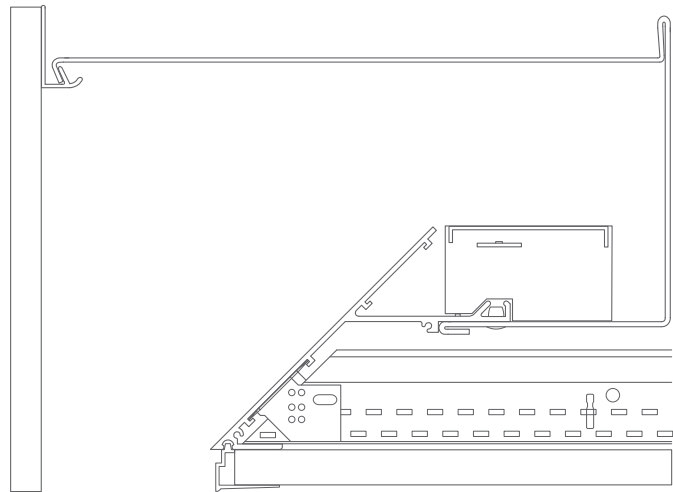

Knife edge

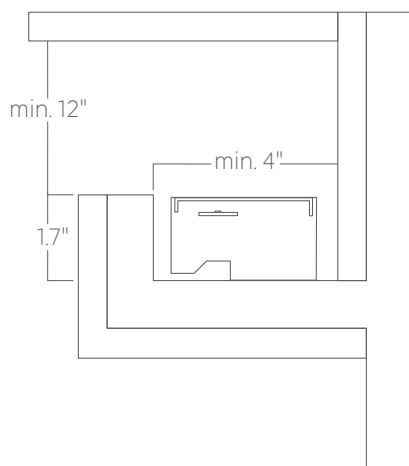

Pre-built cove