

# LS4-EDU indirect/direct



The LS Series of architectural luminaires offers a wide range of profiles and mounting options. Custom lengths and patterns are tailored to suit any modern space.

## Features

- Extruded recycled aluminum housing
- Aluminum core LED boards, specifiable optics
- Specifiable color temperature. CRI > 90, R9 >50
- Custom lengths, welded patterns, and finishes available
- Integral specifiable dimmable drivers or PoE
- 5 Year, 50,000 hour warranty
- WELL Building Standard compatible [learn more](#)

## Dimensions

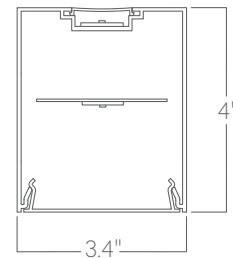

## Optics

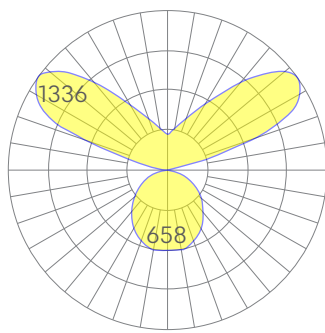

low

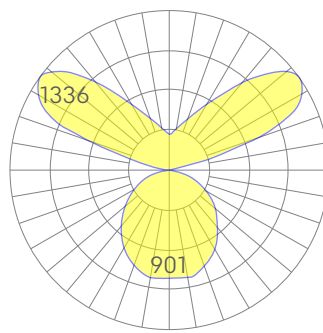

medium

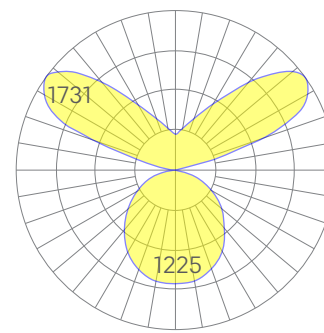

high

Representative distribution and peak candela. For other options see order information or IES files [here](#).

# LS4-EDU indirect/direct

## Ordering Information



Example: LS4 UPDN - 8 - 35 - MED - MED - UNV - DB - W - AC - SD - SD - CCS - DAYCKT - NA

<b>Fixture ID</b> <input type="text" value="1"/>	<b>Length</b> <input type="text" value="2"/>	<b>Color Temperature</b> <input type="text" value="3"/>	<b>Output</b> <input type="text" value="4a-"/> <input type="text" value="4b-"/>
<b>LS4 UPDN</b>	<b>2</b> 2 ft <b>4</b> 4 ft <b>8</b> 8 ft <b>X'-X"</b> Specify Length <sup>1</sup> <b>PAT</b> Pattern (Consult Factory)	<b>27</b> 2700K/90 CRI <b>30</b> 3000K/90 CRI <b>35</b> 3500K/90 CRI <b>40</b> 4000K/90 CRI <b>50</b> 5000K/90 CRI  <b>WD</b> <sup>1</sup> Warm Dim 2200K-3000K <b>TW</b> <sup>2</sup> Tunable white 2700K-6500K <b>RGBW30</b> <sup>3</sup> RGB +white, 3000k <b>RGBW35</b> <sup>3</sup> RGB +white, 3500k <b>RGBW40</b> <sup>3</sup> RGB +white, 4000k	<b>4a - Indirect</b> <b>LOW</b> Low output <b>MED</b> Medium output <b>HIGH</b> High output <b>CUST</b> Custom output <sup>1</sup>  <b>4b - Direct</b> <b>LOW</b> Low output <b>MED</b> Medium output <b>HIGH</b> High output <b>CUST</b> Custom output <sup>1</sup>
<b>Voltage</b> <input type="text" value="5"/>	<b>Driver</b> <input type="text" value="6"/>	<b>Finish</b> <input type="text" value="7"/>	<b>Mounting</b> <input type="text" value="8"/>
<b>UNV 347V</b> Universal (120/277V) 347V	<b>DB</b> Standard 0-10V 1% <b>DB.1%</b> 0-10V 0.1% <b>ELV</b> 2-wire 1% (120V only) <b>TRI</b> Forward phase (120V only) <b>LDE1</b> Lutron Digital EcoSystem <b>JA8</b> JA8 compliant 1% dimming <b>DALI</b> DALI-2 Driver <b>PoE</b> Power over ethernet. <b>TW10</b> Dual channel, 0-10V for tunable white. <b>WD10</b> 0-10V Warm Dim <b>PSQ</b> Lutron T-Series 2-channel 1% for tunable white <b>DMX</b> <sup>1</sup> DMX512	<b>W</b> White <b>BLK</b> Black <b>CC</b> <sup>1</sup> Custom Color <b>CWF</b> <sup>1</sup> Custom Wood Finish	<b>AC</b> Aircraft Cable (50") <b>SM</b> Surface Mount <b>WM</b> Wall Mount <b>PS-X</b> Pendant Stem (12", 18", 24", 36", 48")
<b>Optics</b> <input type="text" value="9a-"/> <input type="text" value="9b-"/>	<b>Sensors/Controls</b> <input type="text" value="10"/>	<b>Circuit</b> <input type="text" value="11"/>	<b>Options</b> <input type="text" value="12"/>
<b>9a - Indirect</b> <b>SD</b> Standard Diffuser <b>AVI-BAT</b> 120° Batwing  <b>9b - Direct</b> <b>SD</b> Standard Diffuser <b>WW</b> Wall Wash Reflector	<b>NA</b> None <b>EIS</b> Enlighted sensor <b>WISM</b> Wattstopper occupancy sensor <b>WISD</b> Wattstopper daylight sensor <b>ECS</b> Eaton WaveLinx sensor <b>ACM</b> Acuity nLight module only <b>ACS</b> Acuity nLight sensor <b>CCS</b> Casambi module	<b>NA</b> None <b>DC</b> <sup>1</sup> Dual Circuit (separate indirect/direct control) <b>EM120V</b> Emergency pack <b>EM277V</b> Emergency pack <b>EMCKT</b> <sup>1</sup> Emergency circuit <b>DAYCKT</b> <sup>1</sup> Daylight circuit	<b>NA</b> None <b>CAN-X</b> <sup>1</sup> Canopy + color <b>SJ-X</b> <sup>2</sup> SJ Cord + color

## Performance

Output <sup>1</sup>	indirect		direct	
	Watts/ft	Lumens/ft	Watts/ft	Lumens/ft
Low	5	523	5	456
Medium	7	716	7	623
High	10	974	10	847

<sup>1</sup>Based on a typically configured 90 CRI, 3500K luminaire using one driver.

Custom outputs available. Please consult factory.  
For 4000K multiply by 1.05; for 3000K 0.9; for 2700K, 0.92.

## Technical Information



click [here](#) or scan QR code

Wiring diagrams, PoE and sensor details

Modification date: October, 2021

Page 2 of 5

# LS4-EDU indirect/direct

## Drivers & Electrical

Integral drivers\* with 0-10V Dimming standard. Several other driver options available; see ordering information.

\*DMX drivers are provided in remote enclosures.

## Sensors & Controls

Sensors are installed on an aluminum plate adjacent to the luminaire lens<sup>1</sup>. Coronet remains agnostic in our approach to sensors and control systems; our fixtures are compatible with most systems offered.

<sup>1</sup>Not applicable to indirect only models. Consult factory.

## Emergency Back-Up

For fixtures three-feet or longer, a 4W integral emergency driver may be wired to 4ft sections. 7W, 10W, and 12W drivers are also available (not all integral; consult factory). Emergency circuits for use with building generators are also available.

## PoE (Power over Ethernet)

Compatible with virtually all PoE systems including Molex Coresync, Igor, Smartengine, Platformatics, and NuLED SPICEbox. Consult Factory for systems not listed, See [here](#) for more info.

## Finishes

All luminaires are finished in high quality polyester powder coating. Our standard color is white. Any RAL color may be specified.

## Weight

7 lbs per foot

## Patterns

Featuring illuminated welded corners and angles. Consult factory for custom designs and elevations.

## Optics

Extruded satin acrylic lenses provide excellent diffusion, high transmission, and no LED imaging.

## Construction

Housings are extruded premium, recycled aluminum. Individual fixtures are available up to 12' long and may be specified as nominal or precision lengths. Precision lengths are supplied within 1/8" tolerance.

## Joined Runs

Runs of any length may be specified and are comprised of multiple, factory-engineered, joined sections. Individually specified luminaires are not field joinable.

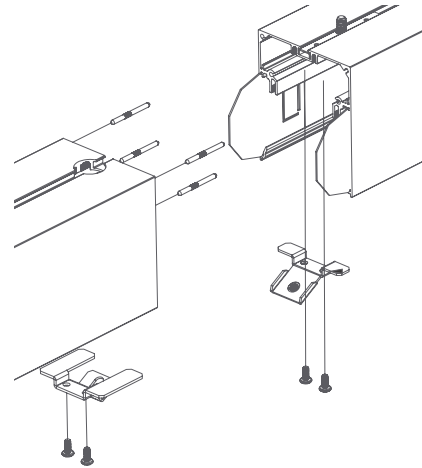

Representative joinery. For product specific details see installation guides or submittal drawings.

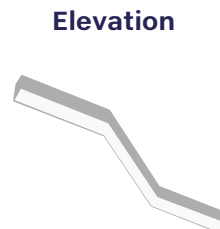
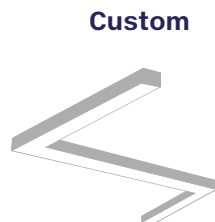
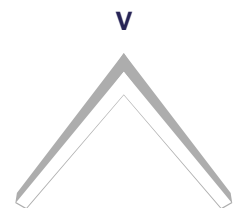
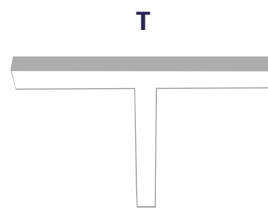
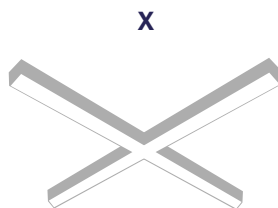
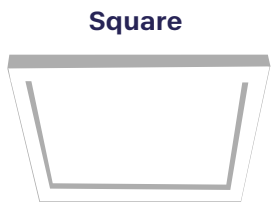

# LS4-EDU indirect/direct

## Mounting Options

Custom mounting types and ceiling transitions available; consult factory.

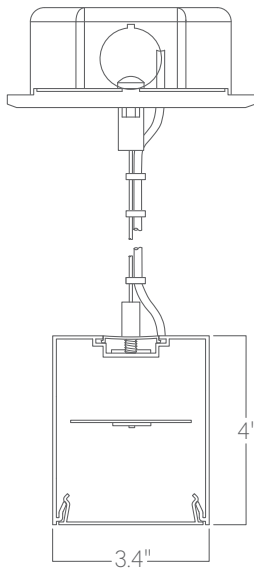

**Aircraft cable**

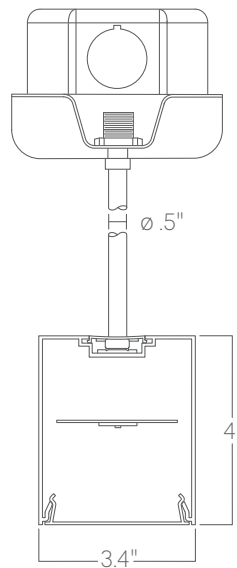

**Pendant stem**

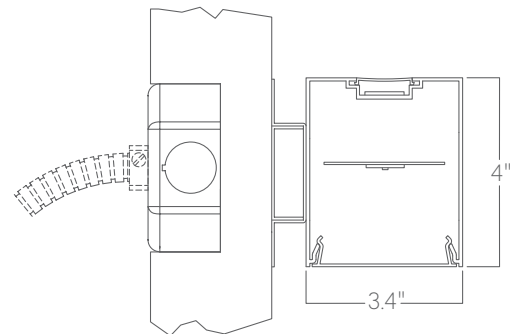

**Wall mount**

# LS4-EDU indirect/direct

## Sample Fixture Layout:

Classroom Size: 30ft x 30ft  
 Ceiling Height: 9.5ft AFF  
 Mounting Height: 8ft AFF  
 Reflectances: 80/50/20  
 Luminaire: LS4 EDU 4FT 3500K LTG1 DB  
 Wattage: 7.25W/ft  
 Lumen Output: 576lm/ft

## Target Levels:

Avg. Foot Candles: 35-50fc  
 Unified Glare Rating: <19

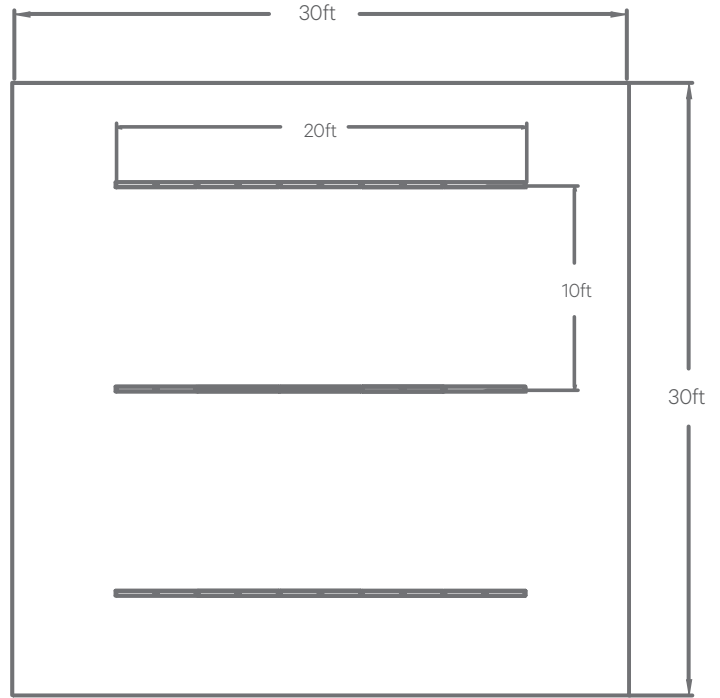

## Calculations:

23	23	22	22	21	21	20	20	19	17	15	10	10	10
24	24	24	23	23	22	21	20	16	10	10	10	10	10
25	25	24	24	23	23	22	21	10	10	10	10	10	10
25	25	24	24	24	23	22	21	16	10	10	10	10	10
25	24	24	24	23	23	22	21	19	15	10	10	10	10
25	24	24	24	23	23	22	21	19	13	10	10	10	10
25	25	25	24	24	23	22	21	16	10	10	10	10	10
25	25	24	24	24	23	22	21	10	10	10	10	10	10
25	25	25	24	24	23	22	21	16	10	10	10	10	10
25	24	24	24	24	23	22	21	19	15	10	10	10	10
25	24	24	24	23	23	22	21	19	14	10	10	10	10
25	25	24	24	24	23	22	21	16	10	10	10	10	10
25	25	24	24	23	23	22	21	10	10	10	10	10	10
24	24	24	24	23	23	22	21	20	16	10	10	10	10
23	23	22	22	21	21	20	20	19	17	13	10	10	10

UGR: 15.15

9.3	13.0	18.6	24.3	28.2	30.4	31.4	31.8	31.4	30.4	28.1	24.2	18.6	13.0	9.3
11.4	17.3	27.5	37.8	44.2	47.4	48.7	49.1	48.7	47.4	44.2	37.7	27.4	17.3	11.4
12.9	20.4	36.2	48.1	56.1	59.8	61.3	61.9	61.4	59.8	56.1	48.0	34.2	20.4	12.9
12.8	19.1	29.8	40.5	47.2	50.7	52.1	52.6	52.1	50.6	47.1	40.4	29.7	19.1	12.8
12.4	16.9	23.8	30.8	35.8	38.7	40.1	40.4	40.0	38.6	35.7	30.7	23.8	16.9	12.4
12.6	17.1	24.1	31.1	36.1	39.0	40.5	40.8	40.4	39.0	36.1	31.0	24.1	17.1	12.6
13.5	19.9	30.7	41.5	48.4	51.8	53.4	53.9	53.4	51.8	48.3	41.5	30.6	19.9	13.5
14.2	22.0	36.0	50.0	58.3	62.3	64.0	64.3	63.8	62.3	58.2	49.9	35.9	21.9	14.2
13.5	19.9	30.8	41.5	48.4	51.8	53.4	53.9	53.4	51.8	48.3	41.5	30.6	19.9	13.5
12.6	17.1	24.1	31.2	36.2	39.1	40.5	40.9	40.5	39.0	36.1	31.1	24.1	17.1	12.6
12.3	16.9	23.8	30.8	35.9	38.8	40.2	40.6	40.2	38.7	35.8	30.8	23.8	16.9	12.3
12.8	19.1	29.8	40.6	47.4	50.8	52.3	52.7	52.2	50.7	47.3	40.5	29.8	19.1	12.8
12.9	20.4	36.2	48.1	56.2	60.0	61.6	62.1	61.6	60.0	56.2	48.0	34.1	20.4	12.9
11.4	17.3	27.5	37.8	44.2	47.4	48.7	49.2	48.7	47.4	44.1	37.7	27.5	17.3	11.4
9.3	13.0	18.6	24.2	28.2	30.4	31.5	31.8	31.5	30.4	28.2	24.2	18.6	13.0	9.3

AVG FC: 36.7