

The GUV Series of architectural luminaires features standard direct lighting and indirect 275nm germicidal ultra violet light for upper-room air disinfection.

Features

- Highly effective upper-room air disinfection
- Extruded recycled aluminum housing
- Aluminum core LED boards, specifiable optics
- Specifiable color temperature. CRI > 90, R9 >50
- Custom lengths, welded patterns, and finishes available
- Integral specifiable dimmable drivers or PoE
- 5 Year, 50,000 hour warranty
- WELL Building Standard compatible [learn more](#)

Dimensions

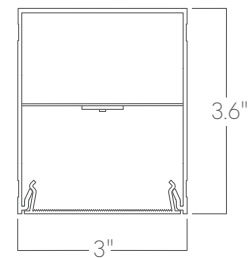

Optics

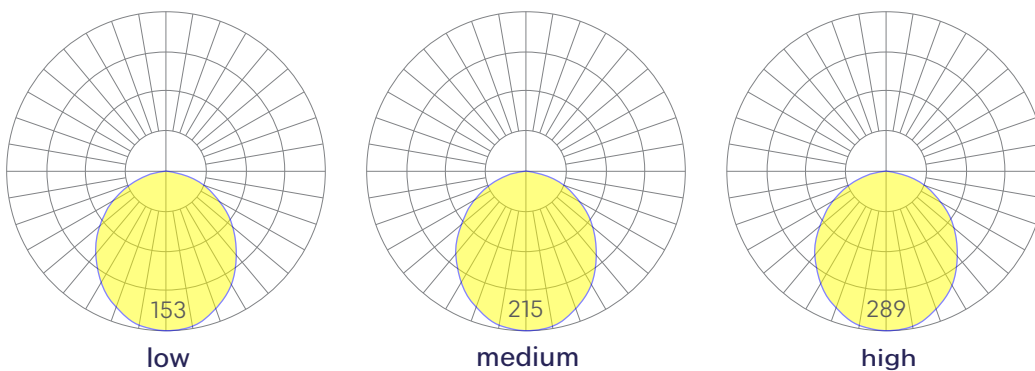

Representative distribution and peak candela. For other options see order information or IES files [here](#).

Ordering Information



Example: LS3 GUV - 8 - 35 - MED - UNV - DB - W - AC - SD - CCS - DAYCKT - NA

Fixture ID	1	Length	2	Color Temperature	3	Output	4
LS3 GUV		2 2 ft 4 4 ft 8 8 ft X'-X'' Specify Length ¹ PAT Pattern (Consult Factory)		27 2700K/90 CRI 30 3000K/90 CRI 35 3500K/90 CRI 40 4000K/90 CRI		LOW Low output MED Medium output HIGH High output CUST Custom output ¹	
		¹ Precision lengths may be specified to the nearest 1/8".				¹ consult factory	
Voltage	5	Driver	6	Finish	7	Mounting	8
UNV 347V ¹	Universal (120/277V) 347V	DB Standard 0-10V 1% DB.1% 0-10V 0.1% ELV 2-wire 1% (120V only) TRI Forward phase (120V only) LDE1 Lutron Digital EcoSystem DALI DALI-2 Driver PoE Power over Ethernet. DMX¹ DMX512		W White BLK Black CC¹ Custom Color CWF¹ Custom Wood Finish		AC Aircraft Cable (50")	
¹ Must use DB Driver		¹ Set to default address 001.RDM capable. Contact us for other addressing needs.		¹ Custom Color. See finish options here. White SJ cord and canopy provided, for other requests, see section 12 to specify.		White canopy provided. Must specify other requests.	
Optics	9	Sensors/Controls	10	Circuit	11	Options	12
SD ASYM	Standard diffuser Asymmetric optic	NA None EIS Enlighted sensor WISM Wattstopper occupancy sensor WISD Wattstopper daylight sensor ECS Eaton WaveLinX sensor ACM Acuity nLight module only ACS Acuity nLight sensor CCS Casambi module		NA None EM120V Emergency Pack EM277V Emergency Pack EMCKT Emergency Circuit DAYCKT Daylight Circuit		NA None AM Antimicrobial finish CAN-X¹ Canopy + color SJ-X² SJ Cord + color	
		Consult factory for other options.				¹ White SJ cord and canopy provided, use above nomenclature for other requests. ² See finish options here.	

Performance

Output ¹	Watts/ft ²	Lumens/ft
Low	5	411
Medium	7	572
High	10	782

¹Based on a typically configured 90 CRI, 3500K luminaire using one driver.
²Indirect GUV LEDs consume additional 5W/ft.

Custom outputs available. Please consult factory.

Technical Information



click [here](#) or scan QR code

Wiring diagrams, PoE and sensor details

Modification date: October,2021

Page 2 of 6

Drivers & Electrical

Integral drivers* with 0-10V Dimming standard. Several other driver options available; see ordering information.

*DMX drivers are provided in remote enclosures.

Sensors & Controls

Sensors are installed on an aluminum plate adjacent to the luminaire lens¹. Coronet remains agnostic in our approach to sensors and control systems; our fixtures are compatible with most systems offered.

¹Not applicable to indirect only models. Consult factory.

Emergency Back-Up

For fixtures three-feet or longer, a 4W integral emergency driver may be wired to 4ft sections. 7W, 10W, and 12W drivers are also available (not all integral; consult factory). Emergency circuits for use with building generators are also available.

PoE (Power over Ethernet)

Compatible with virtually all PoE systems including Moxex Coresync, Igor, Smartengine, Platformatics, and NuLED SPICEbox. Consult Factory for systems not listed, See [here](#) for more info.

Finishes

All luminaires are finished in high quality polyester powder coating. Our standard color is white. Any RAL color may be specified.

Weight

3 lbs per foot

Patterns

Featuring illuminated welded corners and angles. Consult factory for custom designs and elevations.

Optics

Extruded satin acrylic lenses provide excellent diffusion, high transmission, and no LED imaging.

Construction

Housings are extruded premium, recycled aluminum. Individual fixtures are available up to 12' long and may be specified as nominal or precision lengths. Precision lengths are supplied within 1/8" tolerance.

Joined Runs

Runs of any length may be specified and are comprised of multiple, factory-engineered, joined sections. Individually specified luminaires are not field joinable.

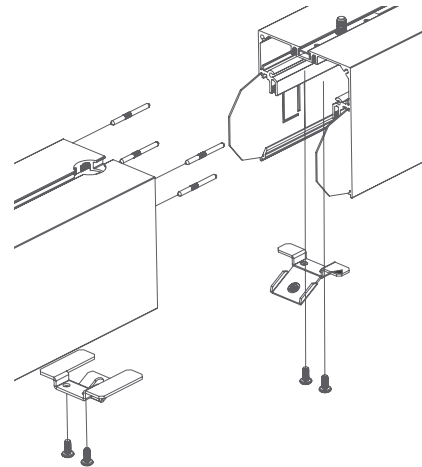

Representative joinery. For product specific details see installation guides or submittal drawings.

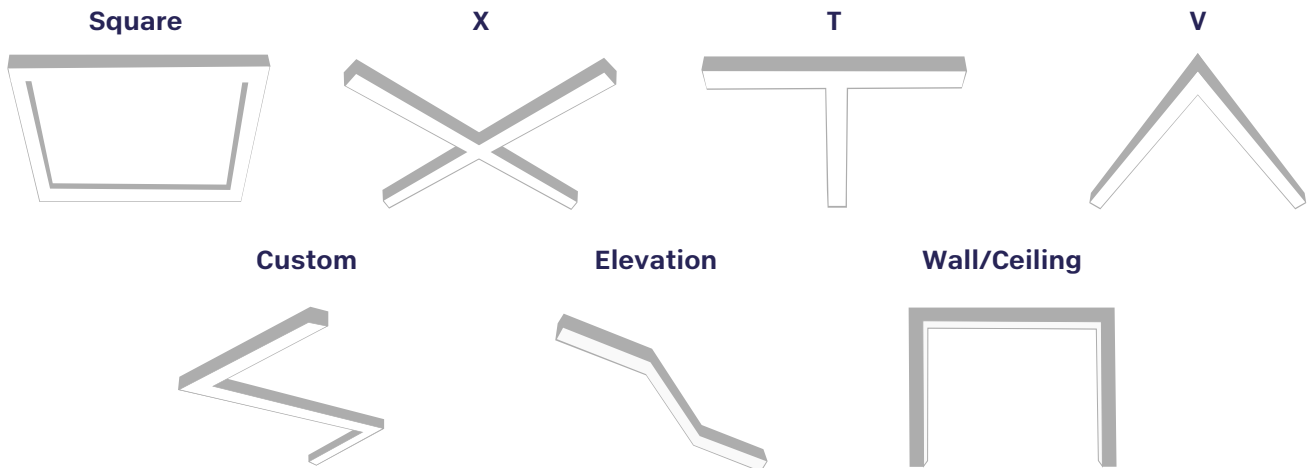

Mounting Options

Custom mounting types and ceiling transitions available; consult factory.

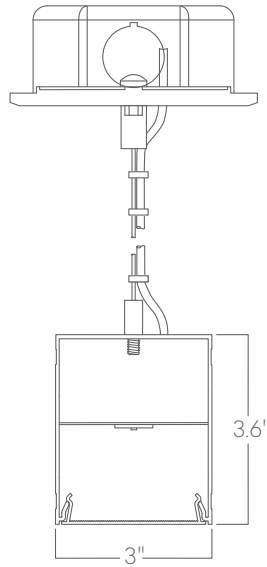

Aircraft cable

UV-C Lighting

Coronet integrates UV-C lighting at 275 nanometers (nm) into our product as upper air germicidal UV to combat virus and bacteria in a space while also providing illumination. UVC wavelengths can break the bonds in the DNA and RNA of viruses and bacteria making them unable to multiply and inactivating them. As the light directly affects the DNA/RNA of the organism, it works on drug resistant strains of viruses and bacteria; this technology has been used in hospitals since the 1940's. There are three bands of UV lighting; UVC, when used in upper air applications, is the most effective, safest solution.

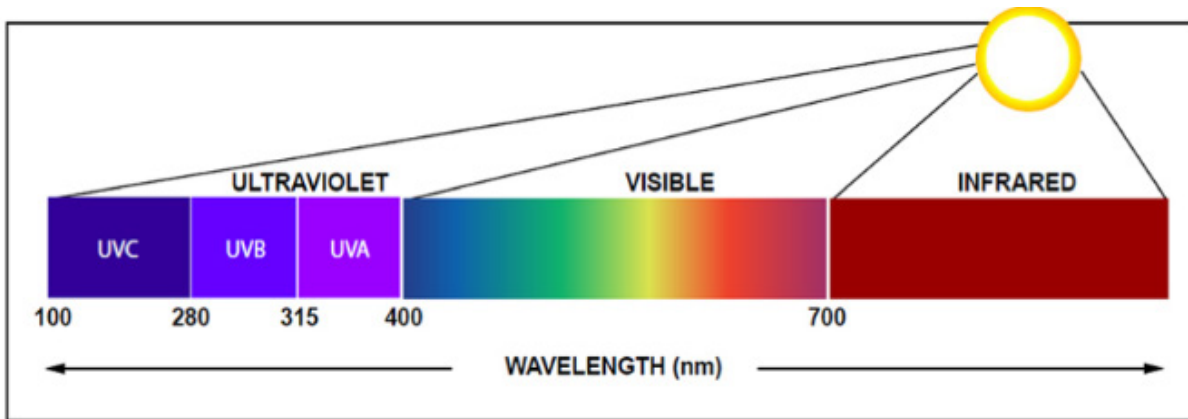

There is an 'Action Curve' that determines how effective specific wavelengths are on Viruses. Below is an example:

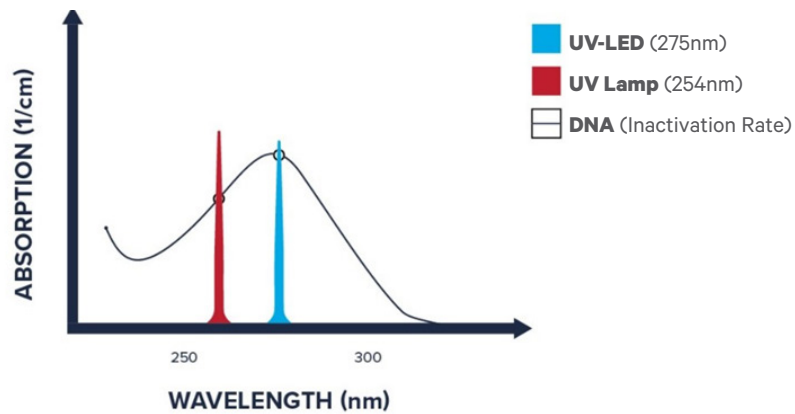

Upper Air GUV

Upper Air GUV uses a UVC light source to clean the air in a room as it circulates. Natural convection that occupants produce combine with the HVAC system and circulate throughout the space. By providing the appropriate dosing (total UV Energy x Time of Exposure), the goal of a well-designed UVC system is to simulate 20-24 air exchanges per hour in a space, helping sanitize against airborne bacteria and viruses by keeping the air clean. Upper Air GUV is effective on aerosolized particles (ie- from a sneeze), but will not clean surfaces below the fixture where droplets may land. As UV-C will not reflect off a ceiling surface, it is "line of sight" disinfection only and should be used in conjunction with a good cleaning/sanitation program.

Design Requirements

Directly viewing UV-C sources can cause harmful effects to the cornea of the eye, Coronet's fixtures are designed to prevent this during normal use in conjunction with important design requirements that allow for safety and optimal germicidal effectiveness:

- All fixtures must be mounted at a minimum of 7'6" to ensure there is no possibility of direct view into the UVC light.
- Fixtures should be at least 2ft from the ceiling to allow for an ideal spread of light and a large enough disinfection zone.
- Fixtures should be evenly spaced throughout a room.
- The lens on the indirect side of the fixture will need to be kept clean for best results otherwise UVC light could be absorbed by dust and lose its efficiency.
- An integrated occupancy sensor will turn off the UV LEDs if motion is detected above the fixture.

The Coronet Approach

Coronet aims to bring this proven technology from the medical community to commercial spaces (offices, retail, hospitality) to be used to help prevent illness in conjunction with a cleaning/disinfection plan to clean surfaces below. By using indirect UV lighting, we can shield the UV-C sources from direct view and ensure there are no safety issues while still providing standard direct LED lighting to illuminate a space. As the fixtures are evenly spaced throughout the room, a less powerful dosage can be used reducing any potential issues of UV-C exposure. Coronet targets the IES recommended 12mW per Cubic Meter of air in the disinfection region for optimal results.

References

With the Covid-19 crisis, worldwide standards organizations have issued opinions on the use of UV-C to target disinfection of space. Respected organizations are recommending Upper Air GUV as it has been proven safe and effective for the last 80 years.

- IES paper on Germicidal UV: <https://www.ies.org/standards/committee-reports/>
- CIE's Position Report on Germicidal UV: <http://cie.co.at/publications/cie-position-statement-use-ultraviolet-uv-radiation-manage-risk-covid-19-transmission>