

V Square indirect/direct



Our linear architectural luminaires offer a wide range of profiles and mounting options. Custom lengths and patterns are tailored to suit any modern space.

Features

- Extruded, recycled aluminum housing
- Aluminum core LED boards, specifiable optics
- Specifiable color temperature. CRI > 90, R9 >50
- Custom lengths, welded patterns, and finishes available
- Specifiable dimmable drivers or PoE
- 5 Year, 50,000 hour warranty
- WELL Building Standard compatible [learn more](#)

Dimensions

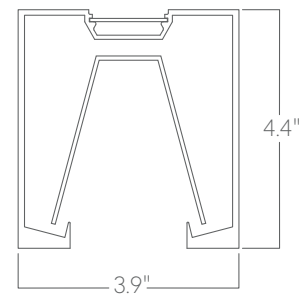

Optics

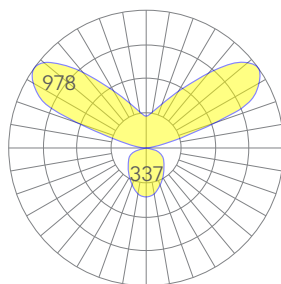

low

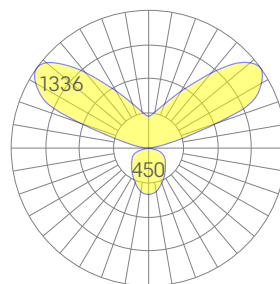

medium

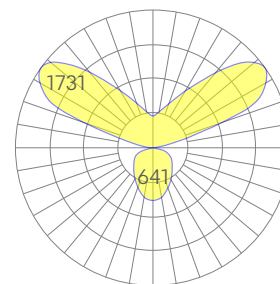

high

Representative distribution and peak candela. For other options see order information. See IES files [here](#).

V Square indirect/direct

Ordering Information



Example: V SQ UPDN - 8 - 35 - MED - MED - UNV - DB - W - AC - SD - SD - CCS - DAYCKT - NA

Fixture ID <input type="text" value="1"/>	Length <input type="text" value="2"/>	Color Temperature <input type="text" value="3"/>	Output <input type="text" value="4a-"/> <input type="text" value="4b-"/>
V SQ UPDN	2 2 ft 4 4 ft 8 8 ft X'-X" Specify Length ¹ PAT Pattern (Consult Factory)	27 2700K/90 CRI 30 3000K/90 CRI 35 3500K/90 CRI 40 4000K/90 CRI 50 5000K/90 CRI	4a - Indirect LOW Low output MED Medium output HIGH High output CUST Custom output ¹ 4b - Direct LOW Low output MED Medium output HIGH High output CUST Custom output ¹
Voltage <input type="text" value="5"/>	Driver <input type="text" value="6"/>	Finish <input type="text" value="7"/>	Mounting <input type="text" value="8"/>
UNV 347V¹ Universal (120/277V) 347V	DB Standard 0-10V 1% DB.1% 0-10V 0.1% ELV 2-wire 1% (120V only) TRI Forward phase (120V only) LDE1 Lutron Digital EcoSystem DALI DALI-2 Driver PoE Power over Ethernet. DMX¹ DMX512	W White BLK Black CC¹ Custom Color CWF¹ Custom Wood Finish	AC Aircraft Cable (50")
Optics <input type="text" value="9a-"/> <input type="text" value="9b-"/>	Sensors/Controls <input type="text" value="10"/>	Circuit <input type="text" value="11"/>	Options <input type="text" value="12"/>
9a - Indirect SD Standard Diffuser AVI-BAT 120° Batwing 9b - Direct SD Standard Diffuser	NA None ACM Acuity nLight Module Only CCS Casambi Module	NA None DC¹ Dual Circuit (separate indirect/direct control) EM120V Emergency pack EM277V Emergency pack EMCKT¹ Emergency circuit DAYCKT¹ Daylight circuit	NA None CAN-X¹ Canopy + color SJ-X² SJ Cord + color

Performance

Output ¹	indirect		direct	
	Watts/ft	Lumens/ft	Watts/ft	Lumens/ft
Low	5	475	5	226
Medium	7	634	7	301
High	10	903	10	430

¹Based on a typically configured 90 CRI, 3500K luminaire using one driver.

Custom outputs available. Please consult factory.
For 4000K multiply by 1.05; for 3000K 0.9%; for 2700K, 0.92.

Technical Information



click [here](#) or scan QR code

Wiring diagrams, PoE and sensor details

Modification date: October, 2021

Page 2 of 4

V Square indirect/direct

Drivers & Electrical

Integral drivers* with 0-10V Dimming standard. Several other driver options available; see ordering information.

*DMX drivers are provided in remote enclosures.

Controls

Control modules may be mounted within luminaires or remotely.

Emergency Back-Up

For fixtures three-feet or longer, a 4W integral emergency driver may be wired to 4ft sections. 7W, 10W, and 12W drivers are also available (not all integral; consult factory). Emergency circuits for use with building generators are also available.

PoE (Power over Ethernet)

Compatible with virtually all PoE systems including Molex Coresync, Igor, Smartengine, Platformatics, and NuLED SPICEbox. Consult Factory for systems not listed, See [here](#) for more info.

Finishes

All luminaires are finished in high quality polyester powder coating. Our standard color is white. Any RAL color may be specified.

Weight

5 lbs per foot

Patterns

Featuring illuminated welded corners and angles. Consult factory for custom designs.

Optics

Extruded satin acrylic lenses provide excellent diffusion, high transmission, and no LED imaging.

Construction

Housings are extruded premium, recycled aluminum. Individual fixtures are available up to 12' long and may be specified as nominal or precision lengths. Precision lengths are supplied within 1/8" tolerance.

Joined Runs

Runs of any length may be specified and are comprised of multiple, factory-engineered, joined sections. Individually specified luminaires are not field joinable.

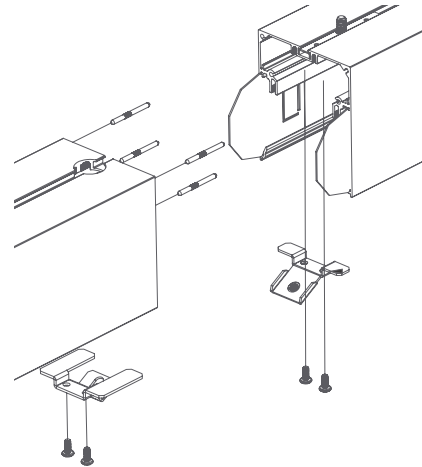

Representative joinery. For product specific details see installation guides or submittal drawings.

Square



X

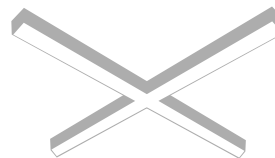

V Square indirect/direct

Mounting Options

Custom mounting types and ceiling transitions available; consult factory.

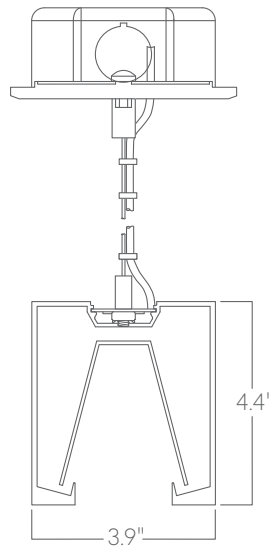

Aircraft cable