

LS1 Pop-Out-Lens indirect/direct

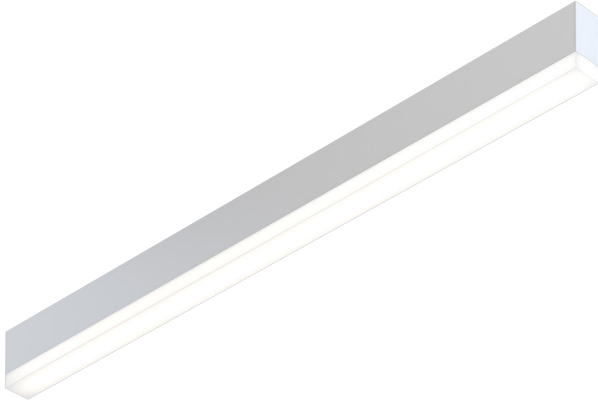

The LS Series of architectural luminaires offers a wide range of profiles and mounting options. Custom lengths and patterns are tailored to suit any modern space.

Features

- Extruded recycled aluminum housing
- Aluminum core LED boards, specifiable optics
- Specifiable color temperature. CRI > 90, R9 >50
- Custom lengths, welded patterns, and finishes available
- Integral specifiable dimmable drivers or PoE
- 5 Year, 50,000 hour warranty
- WELL Building Standard compatible [learn more](#)

Dimensions

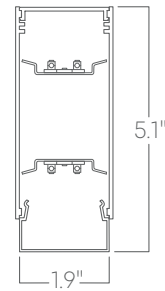

Optics

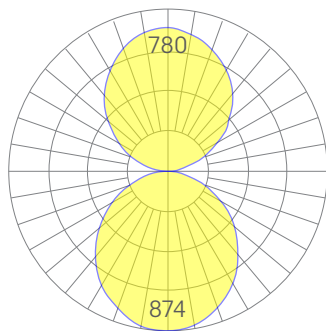

standard

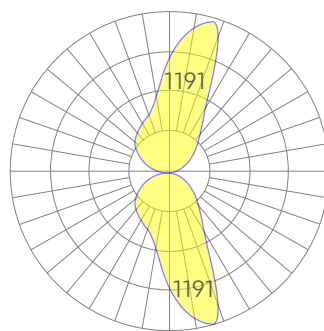

avi asymmetric

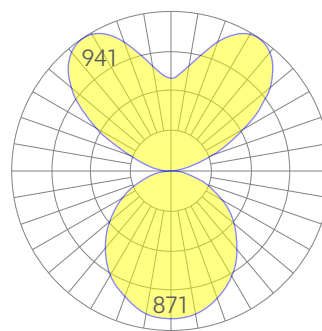

batwing

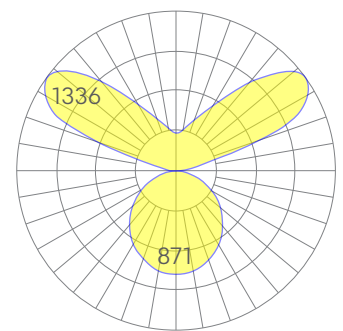

avi-batwing

Representative distribution and peak candela. For other options see order information or IES files [here](#).

LS1 Pop-Out-Lens indirect/direct

Ordering Information



Example: LS1 POL UPDN - 8 - 35 - MED - MED - UNV - DB - W - AC - POL - POL - CCS - DAYCKT - NA

Fixture ID <input type="text" value="1"/>	Length <input type="text" value="2"/>	Color Temperature <input type="text" value="3"/>	Output <input type="text" value="4a-"/> <input type="text" value="4b-"/>	
LS1 POL UPDN	2 2 ft 4 4 ft 8 8 ft X"-X" Specify Length PAT Pattern (Consult Factory)	27 2700K/90 CRI 30 3000K/90 CRI 35 3500K/90 CRI 40 4000K/90 CRI 50 5000K/90 CRI WD¹ Warm Dim 2200K-3000K TW² Tunable White 2700K-6500K RGBW30³ RGB +white, 3000k RGBW35³ RGB +white, 3500k RGBW40³ RGB +white, 4000k	4a - Indirect LOW Low output MED Medium output HIGH High output CUST Custom output ¹ 4b - Direct LOW Low output MED Medium output HIGH High output CUST Custom output ¹	
<small>¹Precision lengths may be specified to the nearest 1/8".</small>				
Voltage <input type="text" value="5"/>	Driver <input type="text" value="6"/>	Finish <input type="text" value="7"/>	Mounting <input type="text" value="8"/>	
UNV 347V¹ Universal (120/277V) 347V	DB Standard 0-10V 1% DB.1% 0-10V 0.1% ELV 2-wire 1% (120V only) TRI Forward phase (120V only) LDE1 Lutron Digital EcoSystem JA8 JA8 compliant 1% dimming DALI DALI-2 Driver PoE Power over ethernet. TW10 Dual channel, 0-10V for tunable white. WD10 0-10V Warm Dim PSQ Lutron T-Series 2-channel 1% for tunable white DMX¹ DMX512	W White BLK Black CC¹ Custom Color CWF¹ Custom Wood Finish	AC Aircraft Cable (50") AC3.5 3.5" canopy + jbox adaptor ¹ SM Surface Mount WM Wall Mount PS-X Pendant Stem (12", 18", 24", 36", 48")	
<small>¹Must use DB Driver</small>				
<small>¹Set to default address 001. RDM capable. Contact us for other addressing needs. All DMX drivers provided in remote enclosures.</small>				
<small>¹Custom Color. See finish options here.</small>				
<small>White SJ cord and canopy provided, for other requests, see section 12 to specify.</small>				
<small>¹Adaptor must be mudded-in</small>				
<small>White stems and canopy provided unless otherwise specified in options (section 12).</small>				
Optics <input type="text" value="9a-"/> <input type="text" value="9b-"/>	Sensors/Controls <input type="text" value="10"/>	Circuit <input type="text" value="11"/>	Options <input type="text" value="12"/>	
9a - Indirect FL Flat Diffuser POL 1" Pop Out Lens BW 70° Batwing AVI-BAT 120° Batwing ASYM Asymmetric Optic 9b - Direct POL 1" Drop Below Lens FL Flat Diffuser	NA None EIS Enlighted sensor WISM Wattstopper occupancy sensor WISD Wattstopper daylight sensor ACM Acuity nLight module only ACS Acuity nLight sensor CCS Casambi module	NA None DC¹ Dual Circuit (separate indirect/direct control) EM120V Emergency pack EM277V Emergency pack EMCKT¹ Emergency circuit DAYCKT¹ Daylight circuit	NA None CAN-X¹ Canopy + color SJ-X² SJ Cord + color	
<small>Consult factory for other options.</small>				
<small>¹May require additional power feeds. Consult factory</small>				
<small>¹White SJ cord and canopy provided, use above nomenclature for other requests.</small>				
<small>²See finish options here.</small>				

Performance

Output ¹	indirect		direct	
	Watts/ft	Lumens/ft	Watts/ft	Lumens/ft
Low	5	448	5	394
Medium	7	586	7	517
High	10	808	10	728

¹Based on a typically configured 90 CRI, 3500K luminaire using one driver.

Custom outputs available. Please consult factory.
For 4000K multiply by 1.05; for 3000K 0.9%; for 2700K, 0.92.

Technical Information



click [here](#) or scan QR code

Wiring diagrams, PoE and sensor details

Modification date: April 2022

LS1 Pop-Out-Lens indirect/direct

Drivers & Electrical

Integral drivers* with 0-10V Dimming standard. Several other driver options available; see ordering information.

*DMX drivers are provided in remote enclosures.

Sensors & Controls

Sensors are installed on an aluminum plate adjacent to the luminaire lens¹. Coronet remains agnostic in our approach to sensors and control systems; our fixtures are compatible with most systems offered.

¹Not applicable to indirect only models. Consult factory.

Emergency Back-Up

For fixtures three-feet or longer, a 4W integral emergency driver may be wired to 4ft sections. 7W, 10W, and 12W drivers are also available (not all integral; consult factory). Emergency circuits for use with building generators are also available.

PoE (Power over Ethernet)

Compatible with virtually all PoE systems including Moxel Coresync, Igor, Smartengine, Platformatics, and NuLED SPICEbox. Consult Factory for systems not listed, See [here](#) for more info.

Finishes

All luminaires are finished in high quality polyester powder coating. Our standard color is white. Any RAL color may be specified.

Weight

3 lbs per foot

Patterns

Featuring illuminated welded corners and angles. Consult factory for custom designs and elevations.

Optics

Extruded satin acrylic lenses provide excellent diffusion, high transmission, and no LED imaging.

Construction

Housings are extruded premium, recycled aluminum. Individual fixtures are available up to 12' long and may be specified as nominal or precision lengths. Precision lengths are supplied within 1/8" tolerance.

Joined Runs

Runs of any length may be specified and are comprised of multiple, factory-engineered, joined sections. Individually specified luminaires are not field joinable.

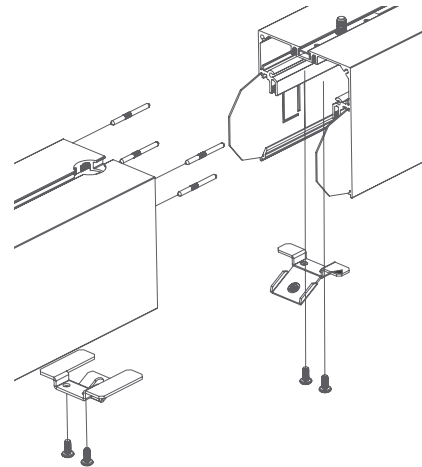

Representative joinery. For product specific details see installation guides or submittal drawings.

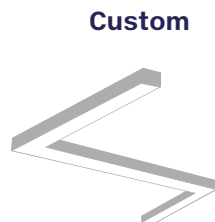
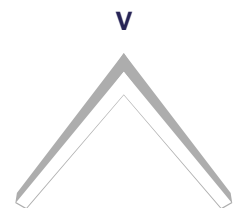
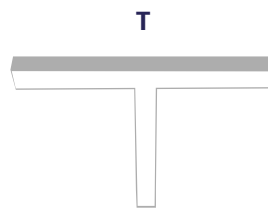
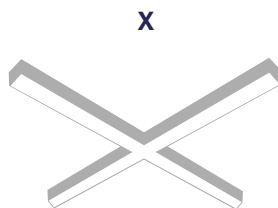
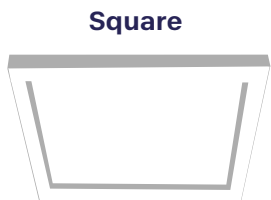

LS1 Pop-Out-Lens indirect/direct

Mounting Options

Custom mounting types and ceiling transitions available; consult factory.

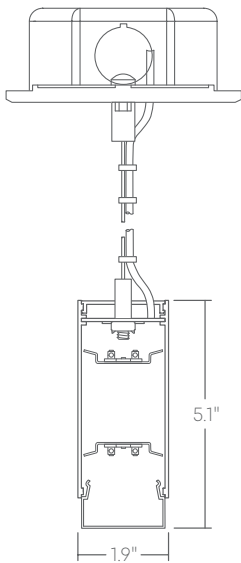

Aircraft cable

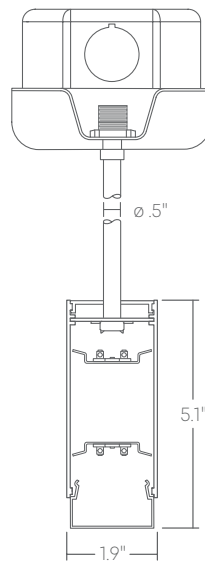

Pendant stem

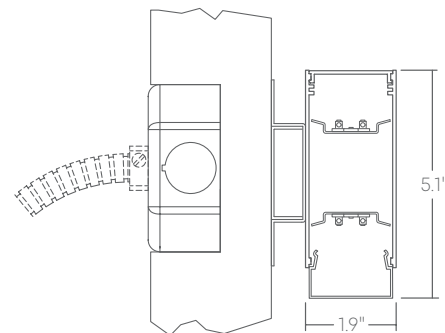

Wall mount