

U indirect/direct



Our linear architectural luminaires offer a wide range of profiles and mounting options. Custom lengths and patterns are tailored to suit any modern space.

Features

- Extruded, recycled aluminum housing
- Aluminum core LED boards, specifiable optics
- Specifiable color temperature. CRI > 90, R9 >50
- Custom lengths, welded patterns, and finishes available
- Specifiable dimmable drivers or PoE
- 5 Year, 50,000 hour warranty, damp location rated
- WELL Building Standard compatible [learn more](#)

Dimensions

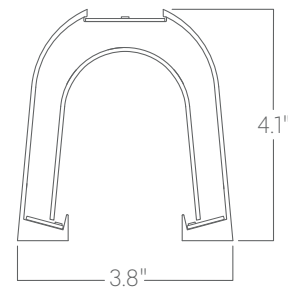

Optics

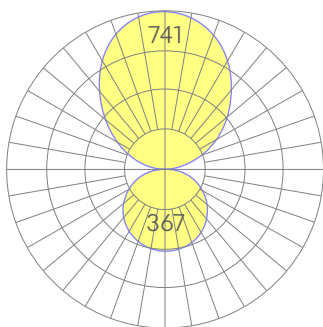

low

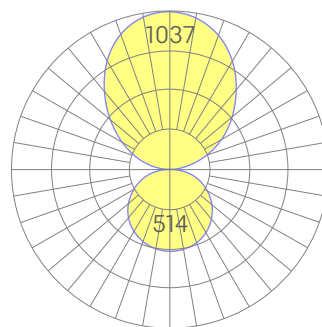

medium

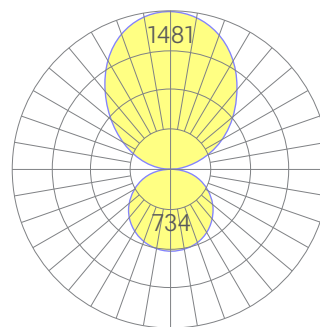

high

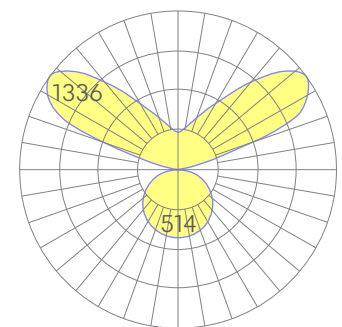

avi asymmetric

Representative distribution and peak candela. For other options see order information. See IES files [here](#).

U indirect/direct

Ordering Information



Example: U UPDN - 8 - 35 - MED - MED - UNV - DB - W - AC - SD - SD - CCS - DAYCKT - NA

Fixture ID	Length	Color Temperature	Output
U UPDN	2 2 ft 4 4 ft 8 8 ft X'-X'' Specify Length PAT Pattern (Consult Factory)	27 2700K/90 CRI 30 3000K/90 CRI 35 3500K/90 CRI 40 4000K/90 CRI 50 5000K/90 CRI	4a - Indirect LOW Low output MED Medium output HIGH High output CUST Custom output ¹ 4b - Direct LOW Low output MED Medium output HIGH High output CUST Custom output ¹
<small>¹Precision lengths may be specified to the nearest 2". All lengths are nominal unless specified to be exact.</small>			
<small>¹consult factory</small>			
Voltage	Driver	Finish	Mounting
UNV 347V ¹ Universal (120/277V) 347V	DB Standard 0-10V 1% DB.1% 0-10V 0.1% ELV ² Reverse Phase 1% (120V only) TRI ² Forward phase (120V only) LDE1 Lutron Digital EcoSystem DALI DALI-2 Driver PoE Power over Ethernet. DMX ¹ DMX512	W White BLK Black SLV Silver CC ¹ Custom Color CWF ¹ Custom Wood Finish	AC Aircraft Cable (50") AC3.5 3.5" canopy + jbox adaptor ¹
<small>¹Set to default address 001. Contact us for other addressing needs. ²For compatible dimmers, click here.</small>			
<small>¹Must use DB Driver</small>			
<small>All drivers remote</small>			
<small>¹Custom Color. See finish options here. White SJ cord and canopy provided; for other requests, see section 12 to specify.</small>			
<small>¹Adaptor must be mudded-in White stems and canopy provided unless otherwise specified in options (section 11).</small>			
Optics	Sensors/Controls	Circuit	Options
9a - Indirect SD Standard Diffuser AVI-BAT 120° Batwing 9b - Direct SD Standard Diffuser	NA None ACM Acuity nLight Module Only CCS Casambi Module AWNLR Lutron Athena Wireless Node Module	NA None DC Dual Circuit (separate indirect/direct control) 10W EMPKT Emergency battery pack EMCKT ¹ Emergency circuit DAYCKT ¹ Daylight circuit	STD White Canopy + White Cord CAN-X ¹ Canopy + color SJ-X ² SJ Cord + color
<small>Consult factory for other options.</small>			
<small>¹May require additional power feeds. Consult factory</small>			
<small>¹See finish options here. ²SJ Cord only available in White or Black.</small>			

Performance

Output ¹	indirect		direct	
	Watts/ft	Lumens/ft	Watts/ft	Lumens/ft
Low	5	475	5	257
Medium	7	697	7	343
High	10	905	10	489

¹Based on a typically configured 90 CRI, 3500K luminaire using one driver.

Custom outputs available. Please consult factory.
For 4000K multiply by 1.05, for 3000K 0.96, for 2700K, 0.92.

Technical Information



click [here](#) or scan QR code

Wiring diagrams, PoE and sensor details

Modification date: June 2023

Page 2 of 4

U indirect/direct

Drivers & Electrical

Remote, dimmable drivers are supplied in enclosures. For remote driver box sizes, click [here](#).

Controls

Control modules may be mounted within luminaires or remotely.

Emergency Back-Up

For fixtures three-feet or longer, a 10W remote emergency driver may be wired to 4ft sections. Emergency circuits for use with building generators are also available.

PoE (Power over Ethernet)

Compatible with virtually all PoE systems including Molex Coresync, Igor, Smartengine, Platformatics, and NuLED SPICEbox. Consult Factory for systems not listed or see [here](#) for more info.

Finishes

All luminaires are finished in high quality polyester powder coating. Our standard color is white. Any RAL color may be specified.

Weight

5 lbs per foot

Patterns

Featuring illuminated welded corners and angles. Consult factory for custom designs.

Optics

Extruded satin acrylic lenses provide excellent diffusion, high transmission, and no LED imaging.

Construction

Housings are extruded premium, recycled aluminum. Individual fixtures are available up to 12' long and may be specified as nominal or precision lengths. Precision lengths are supplied within 1/8" tolerance.

Joined Runs

Runs of any length may be specified and are comprised of multiple, factory-engineered, joined sections. Individually specified luminaires are not field joinable.

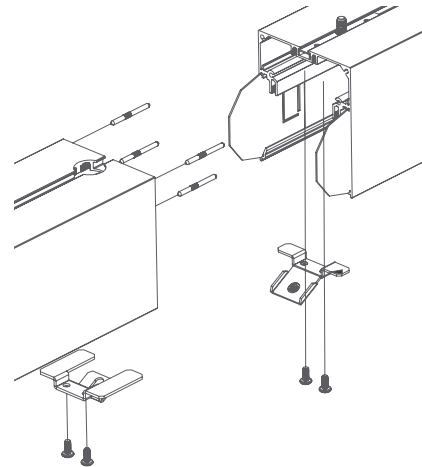

Representative joinery. For product specific details see installation guides or submittal drawings.

Square



X

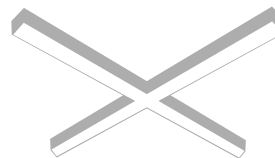

U indirect/direct

Mounting Options

Custom mounting types and ceiling transitions available; consult factory.

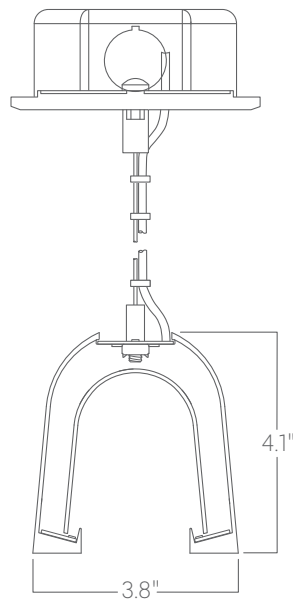

Aircraft cable