

# U direct

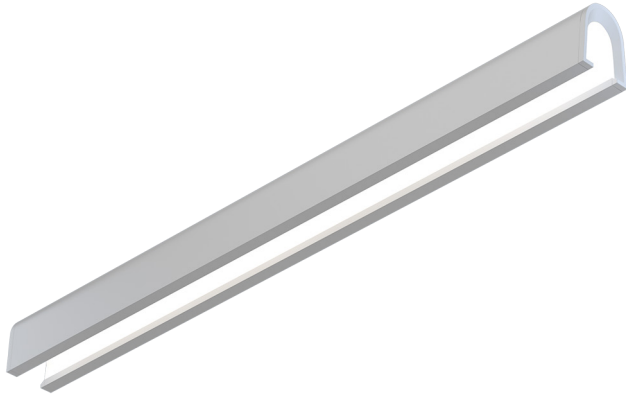

The LS Series of architectural luminaires offers a wide range of profiles and mounting options. Custom lengths and patterns are tailored to suit any modern space.

## Features

- Extruded, recycled aluminum housing
- Aluminum core LED boards, specifiable output
- Specifiable color temperature. CRI > 90, R9 >50
- Custom lengths, welded patterns, and finishes available
- Integral specifiable dimmable drivers or PoE
- 5 Year, 50,000 hour warranty
- WELL Building Standard compatible [learn more](#)

## Dimensions

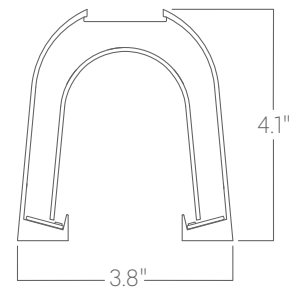

## Optics

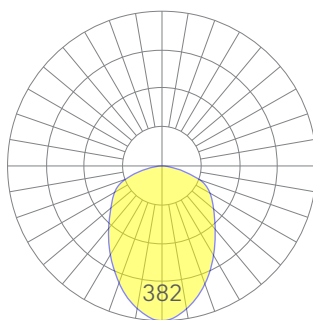

low

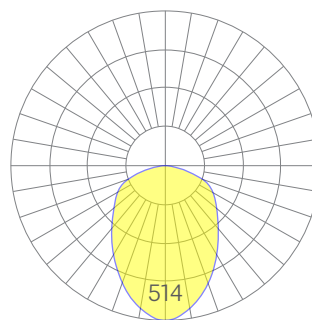

medium

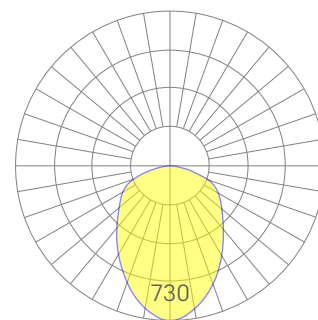

high

Representative distribution and peak candela. For other options see order information or IES files [here](#).

**Ordering Information**



Example: U - 8 - 35 - MED - UNV - DB - W - AC - SD - CCS - DAYCKT - NA

<b>Fixture ID</b> <input type="text" value="1"/>	<b>Length</b> <input type="text" value="2"/>	<b>Color Temperature</b> <input type="text" value="3"/>	<b>Output</b> <input type="text" value="4"/>
U	<b>2</b> 2 ft <b>4</b> 4 ft <b>8</b> 8 ft <b>X'-X"</b> Specify Length <sup>1</sup> <b>PAT</b> Pattern (Consult Factory)	<b>27</b> 2700K/90 CRI <b>30</b> 3000K/90 CRI <b>35</b> 3500K/90 CRI <b>40</b> 4000K/90 CRI <b>50</b> 5000K/90 CRI	<b>LOW</b> Low output <b>MED</b> Medium output <b>HIGH</b> High output <b>CUST</b> Custom output <sup>1</sup>
<small><sup>1</sup>Precision lengths may be specified to the nearest 1/8".</small>			
<b>Voltage</b> <input type="text" value="5"/>	<b>Driver</b> <input type="text" value="6"/>	<b>Finish</b> <input type="text" value="7"/>	<b>Mounting</b> <input type="text" value="8"/>
<b>UNV</b> Universal (120/277V) <b>347V</b> 347V	<b>DB</b> Standard 0-10V 1% <b>DB.1%</b> 0-10V 0.1% <b>ELV</b> 2-wire 1% (120V only) <b>TRI</b> Forward phase (120V only) <b>LDE1</b> Lutron Digital EcoSystem <b>DALI</b> DALI-2 Driver <b>PoE</b> Power over Ethernet. <b>DMX</b> DMX512	<b>W</b> White <b>BLK</b> Black <b>CC</b> Custom Color <b>CWF</b> Custom Wood Finish	<b>AC</b> Aircraft Cable (50")
<small><sup>1</sup>Set to default address 001. RDM capable. Contact us for other addressing needs.</small>	<small>All drivers remote</small>	<small><sup>1</sup>Custom Color. See finish options here. White SJ cord and canopy provided, for other requests, see section 12 to specify.</small>	<small>White canopy provided. Must specify other requests.</small>
<small>*Must use DB Driver</small>			
<b>Optics</b> <input type="text" value="9"/>	<b>Sensors/Controls</b> <input type="text" value="10"/>	<b>Circuit</b> <input type="text" value="11"/>	<b>Options</b> <input type="text" value="12"/>
<b>SD</b> Standard Diffuser	<b>NA</b> None <b>ACM</b> Acuity nLight Module Only <b>CCS</b> Casambi Module	<b>NA</b> None <b>EM120V</b> Emergency Pack <b>EM277V</b> Emergency Pack <b>EMCKT</b> Emergency Circuit <b>DAYCKT</b> Daylight Circuit	<b>NA</b> None <b>CAN-X</b> Canopy + color <b>SJ-X<sup>2</sup></b> SJ Cord + color
	<small>Consult factory for other options.</small>		<small><sup>1</sup>White SJ cord and canopy provided, use above nomenclature for other requests. <sup>2</sup>See finish options here.</small>

**Performance**

Output <sup>1</sup>	Watts/ft	Lumens/ft
Low	5	261
Medium	7	350
High	10	498

<sup>1</sup>Based on a typically configured 90 CRI, 3500K luminaire using one driver.

Custom outputs available. Please consult factory.  
For 4000K multiply by 1.05; for 3000K 0.96; for 2700K, 0.92

**Technical Information**



click [here](#) or scan QR code

Wiring diagrams, PoE and sensor details

Modification date: October,2021

Page 2 of 4

## Drivers & Electrical

Integral drivers\* with 0-10V Dimming standard. Several other driver options available; see ordering information.

\*DMX drivers are provided in remote enclosures.

## Controls

Control modules may be mounted within luminaires or remotely.

## Emergency Back-Up

For fixtures three-feet or longer, a 4W integral emergency driver may be wired to 4ft sections. 7W, 10W, and 12W drivers are also available (not all integral; consult factory). Emergency circuits for use with building generators are also available.

## PoE (Power over Ethernet)

Compatible with virtually all PoE systems including Moxel Coresync, Igor, Smartengine, Platformatics, and NuLED SPICEbox. Consult Factory for systems not listed. See [here](#) for more info.

## Finishes

All luminaires are finished in high quality polyester powder coating. Our standard color is white. Any RAL color may be specified.

## Weight

5 lbs per foot

## Patterns

Featuring illuminated welded corners and angles. Consult factory for custom designs.

## Optics

Extruded satin acrylic lenses provide excellent diffusion, high transmission, and no LED imaging.

## Construction

Housings are extruded premium, recycled aluminum. Individual fixtures are available up to 12' long and may be specified as nominal or precision lengths. Precision lengths are supplied within 1/8" tolerance.

## Joined Runs

Runs of any length may be specified and are comprised of multiple, factory-engineered, joined sections. Individually specified luminaires are not field joinable.

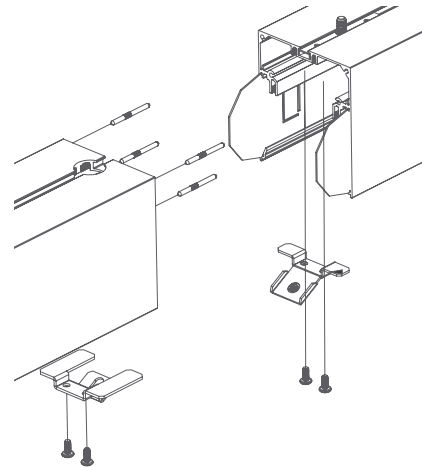

Representative joinery. For product specific details see installation guides or submittal drawings.

**Square**



**X**

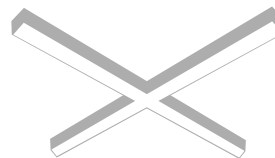

## Mounting Options

Custom mounting types and ceiling transitions available; consult factory.

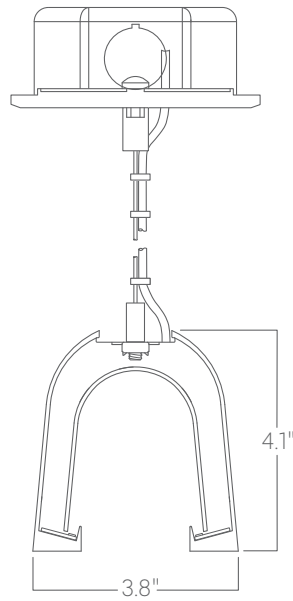

**Aircraft cable**