

Rush Black Optic direct

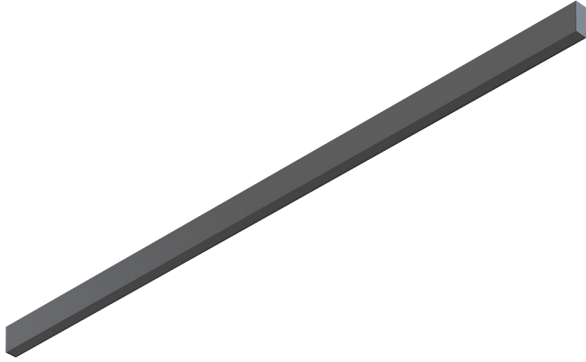

The Black Optic Series of architectural luminaires seamlessly blends into dark surroundings. Custom lengths and patterns are tailored to suit any modern space.

Features

- Extruded, recycled aluminum housing
- Aluminum core LED boards, specifiable output
- Specifiable color temperature. CRI > 90, R9 >50
- Custom lengths, welded patterns, and finishes available
- Integral specifiable dimmable drivers or PoE
- 5 Year, 50,000 hour warranty
- WELL Building Standard compatible [learn more](#)

Dimensions

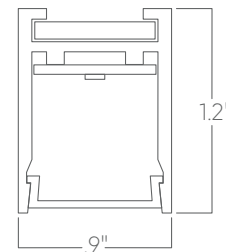

Optics

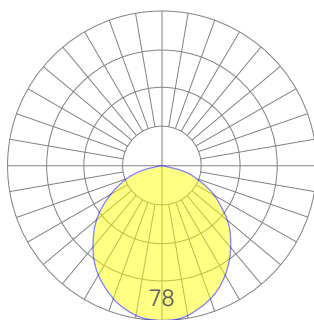

low

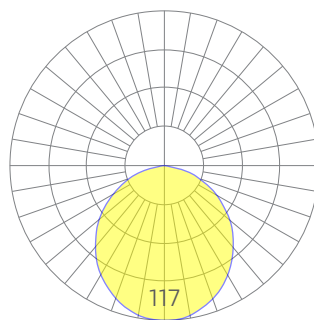

medium

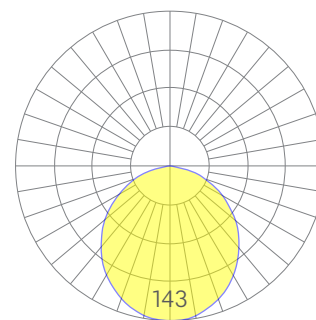

high

Representative distribution and peak candela. For other options see order information or IES files [here](#).

Rush Black Optic direct

Ordering Information

- - - - - - - - - - -

1 2 3 4 5 6 7 8 9 10 11 12

Example: RUSH BKO DN - 8 - 35 - LOW - UNV - DB - W - AC - BKO - CCS - DAYCKT - NA

Fixture ID <input type="text" value="1"/>	Length <input type="text" value="2"/>	Color Temperature <input type="text" value="3"/>	Output <input type="text" value="4"/>
RUSH BKO DN	4 4 ft 8 8 ft X'-X" Specify Length ¹ PAT Pattern (Consult Factory)	27 2700K/90 CRI 30 3000K/90 CRI 35 3500K/90 CRI 40 4000K/90 CRI	LOW Low output MED Medium output HIGH High output CUST Custom output ¹
<small>¹Precision lengths may be specified to the nearest 1/8".</small>			
Voltage <input type="text" value="5"/>	Driver <input type="text" value="6"/>	Finish <input type="text" value="7"/>	Mounting <input type="text" value="8"/>
UNV 347V¹ Universal (120/277V) 347V	DB Standard 0-10V 1% DB.1% 0-10V 0.1% ELV 2-wire 1% (120V only) TRI Forward phase (120V only) LDE1 Lutron Digital EcoSystem DALI DALI-2 Driver PoE Power over ethernet. TW10 Dual channel, 0-10V for tunable white. WD10 0-10V Warm Dim PSQ Lutron T-Series 2-channel 1% for tunable white DMX¹ DMX512	W White BLK Black CC¹ Custom Color CWF¹ Custom Wood Finish	ACP Power Over Aircraft Cable AC Aircraft Cable (50") SM Surface Mount WM Wall Mount PS-X Pendant Stem (12", 18", 24", 36", 48")
<small>¹Must use DB Driver</small>	<small>¹Set to default address 001.RDM capable. Contact us for other addressing needs.</small>	<small>¹Custom Color. See finish options here. White SJ cord and canopy provided, for other requests, see section 12 to specify.</small>	<small>White stems and canopy provided. Must specify other requests.</small>
Optics <input type="text" value="9"/>	Sensors/Controls <input type="text" value="10"/>	Circuit <input type="text" value="11"/>	Options <input type="text" value="12"/>
BKO Black Optic	NA None EIS Enlighted sensor WISM Wattstopper occupancy sensor WISD Wattstopper daylight sensor ECS Eaton WaveLinX sensor ACM Acuity nLight module only ACS Acuity nLight sensor CCS Casambi module	NA None EM120V Emergency Pack EM277V Emergency Pack EMCKT Emergency Circuit DAYCKT Daylight Circuit	NA None CAN-X¹ Canopy + color SJ-X² SJ Cord + color
	<small>Consult factory for other options.</small>		<small>¹White SJ cord and canopy provided, use above nomenclature for other requests. ²See finish options here.</small>

Performance

Output ¹	Watts/ft	Lumens/ft
Low	4	53
Medium	5	79
High	7	100

¹Based on a typically configured 90 CRI, 3500K luminaire using one driver.

Custom outputs available. Please consult factory.
For 4000K multiply by 1.05; for 3000K 0.96; for 2700K, 0.92

Technical Information



Click [here](#) or scan QR code

Wiring diagrams, PoE and sensor details

Modification date: October, 2021

Page 2 of 4

Rush Black Optic direct

Drivers & Electrical

Remote, dimmable drivers are supplied in enclosures.

Sensors & Controls

Sensors are installed on an aluminum plate adjacent to the luminaire lens. Coronet remains agnostic in our approach to sensors and control systems; our fixtures are compatible with most systems offered.

Emergency Back-Up

Emergency circuits for use with building generators available

PoE (Power over Ethernet)

Compatible with virtually all PoE systems including Molex Coresync, Igor, Smartengine, Platformatics, and NuLED SPICEbox. Consult Factory for systems not listed, See [here](#) for more info.

Finishes

All luminaires are finished in high quality polyester powder coating. Our standard color is white. Any RAL color may be specified.

Weight

per foot

Optics

Room facing lens is black when unilluminated, seamlessly blending into dark environments. Uplight is available for some models.

Construction

Housings are extruded premium, recycled aluminum. Individual fixtures are available up to 12' long and may be specified as nominal or precision lengths. Precision lengths are supplied within 1/8" tolerance.

Joined Runs

Runs of any length may be specified and are comprised of multiple, factory-engineered, joined sections. Individually specified luminaires are not field joinable.

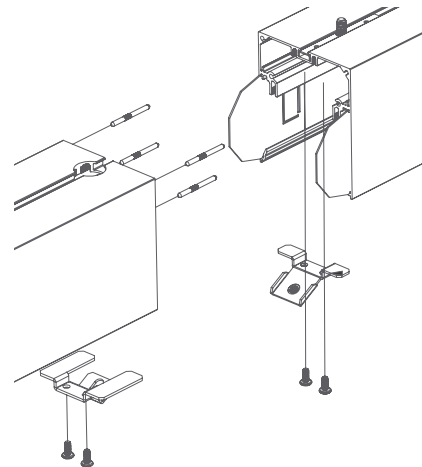

Representative joinery. For product specific details see installation guides or submittal drawings.

Patterns

Featuring illuminated welded corners and angles. Consult factory for custom designs.

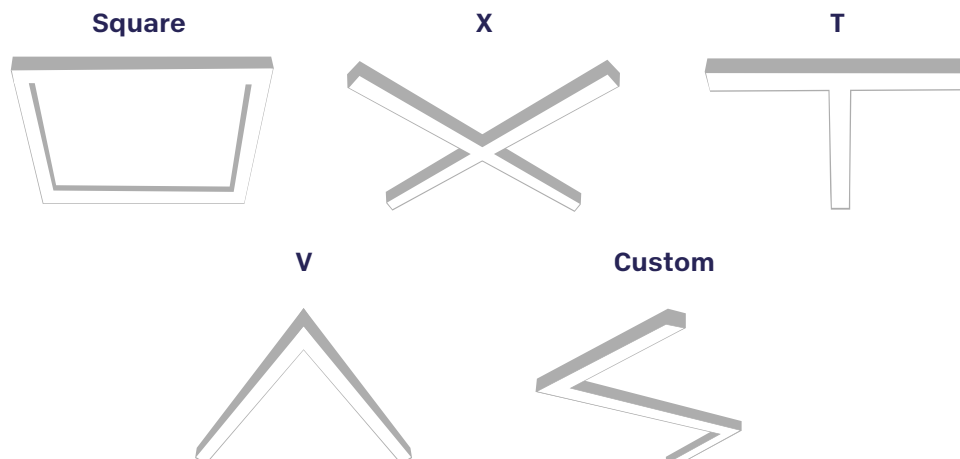

Rush Black Optic direct

Mounting Options

Custom mounting types and ceiling transitions available; consult factory.

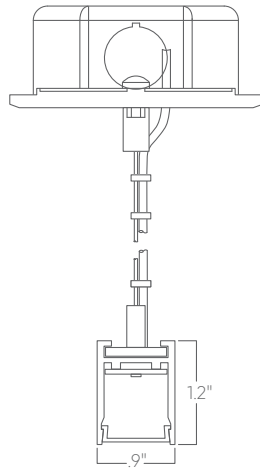

Aircraft cable

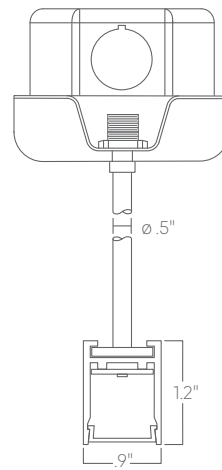

Pendant stem

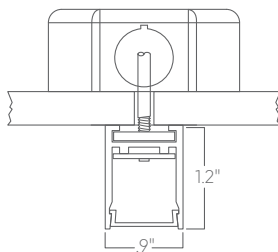

Surface mount

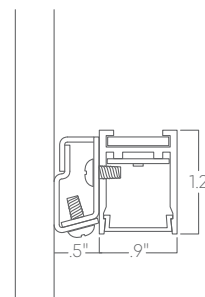

Wall mount