

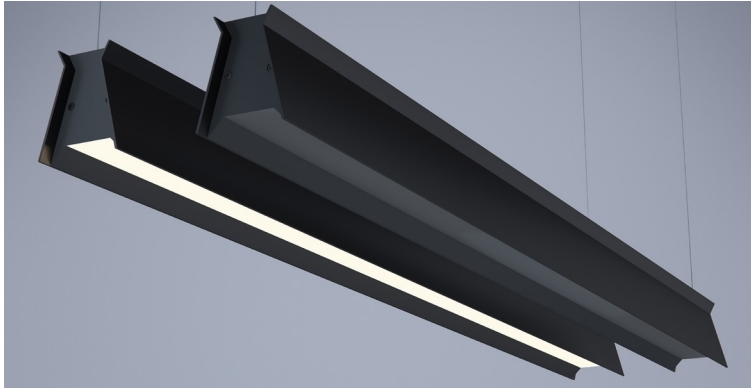



DATE	PROJECT	FIRM	TYPE
------	---------	------	------



Stylized architectural linear luminaire with direct lighting. Specially formulated, regressed lens in beveled aperture that allows the unilluminated fixture to seamlessly blend in to dark environments and delivers full illumination when switched on. Perfect for open ceiling applications and architectural spaces.

FEATURES

- **BLACK OPTIC**
- 100% Direct Lighting
- Available In Made To Measure Lengths Accurate Up To 1/16"
- Patterns Available (See Page 2)
- CRI 90+ Standard; R9>50
- 5 Year, 50,000 Hour Fixture Warranty
- 2700K, 3000K, 3500K, 4000K & 5000K Color Temperatures Available
- Available with PoE

APPLICATIONS	Offices, Lobbies, Retail Stores, Restaurants, Reception Areas & Corridors		
CONSTRUCTION	Extruded Aluminum Housing with Die Cast Ends. Formed Steel Gear Tray	OPTICS	BLACK OPTIC
WARRANTY	5 Year Limited Warranty (Covers Standard Components)	FINISH	Standard Powder-Coated White. Custom RAL Colors Available
FIXTURE RATINGS & CERTIFICATIONS	Union Made ETL Listed	Made In The USA Damp Location Rated	 
ELECTRICAL	Integral Driver with 0-10V Dimming Standard. Several Driver Options Available		DRIVERS & SENSORS For Wiring Diagrams and Sensor Information Click Here 

EXTRUSION DIMENSIONS

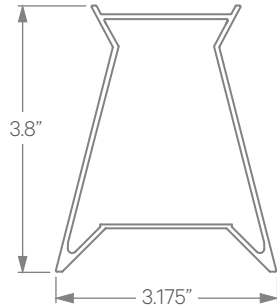

ORDERING	1	2	3	4	5	6	7	8	9	10
----------	---	---	---	---	---	---	---	---	---	----

1 - FIXTURE ID PIER LED - BKO™	2 - LENGTH 2 - 2 ft 4 - 4 ft 8 - 8 ft X'-X" - Specify Length PAT - Pattern (Consult Factory)	3 - COLOR TEMP 27 - 2700K/90 CRI 30 - 3000K/90 CRI 35 - 3500K/90 CRI 40 - 4000K/90 CRI 50 - 5000K/90 CRI TW* - Tunable White *Must use DMX or TW10 Driver	4 - LED SYSTEM LTG1 - Standard LTG2 - Low LTG3 - High LTGC - Custom Output	5 - VOLTAGE UNV - Universal (120/277V)	6 - DRIVER DB - Standard Dimming (0-10V) DB1% - 1% Dimming (0-10V) DB.1% - 0.1% Dimming (0-10V) LTEA - Lutron 2-wire 1% Dimming (120V only) LDE1 - Lutron Digital EcoSystem LDE5 - 5 Series EcoSystem; 5% Dimming PoE - Power over Ethernet. Consult Factory for Compatibility DMX - For Color Tuning and RGBW (Remote) TW10 - Dual Channel, 0-10V For Color Tuning (CCT and Intensity Control)
7 - FINISH BLK* - Black (Standard) W* - White CC* - Custom Color (provide RAL#) *White cord and canopy provided. Must specify for other requests.	8 - MOUNTING AC - Air Craft Cable (50")	9 - CONTROL (Optional) EIS - Enlighted Sensor WISD - Wattstopper Daylight Sensor WISM - Wattstopper Occupancy Sensor SLS - SensiLUM Sensor ACS - Acuity Controls nLight System CCS - Casambi Compatible ECS - Eaton WaveLinx System *For other control systems not listed consult factory.	10 - OTHER OPTIONS EMCKT - Emergency Circuit		

Updated: 05/30/2019

DATE

PROJECT

FIRM

TYPE

MOUNTING OPTIONS

AC - Air Craft Cable (50")

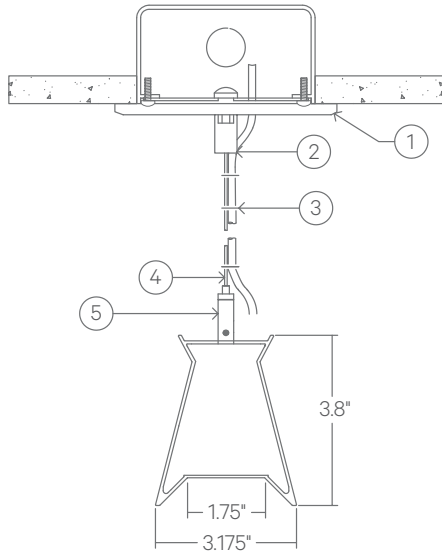

- 1 - 5" Round Canopy (Standard White Finish)
- 2 - Canopy Retainer
- 3 - SJT Cord (Standard White)
- 4 - Air Craft Cable
- 5 - Gripper

PATTERNS

Patterns feature illuminated corners and angles. **Must consult factory for custom corners, patterns and elevations.**

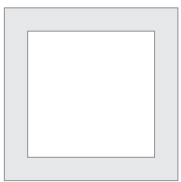

Square Patterns

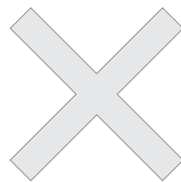

X Patterns

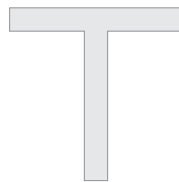

T Patterns



Custom Angles

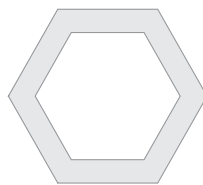

Custom Patterns

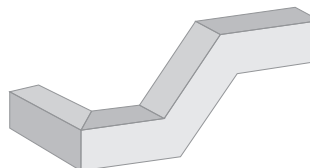

Custom Elevations

LENS CUT

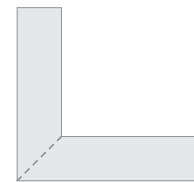

Mitered