

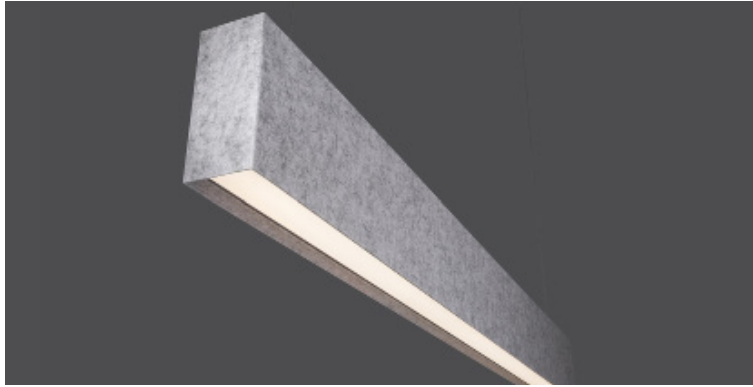



DATE	PROJECT	FIRM	TYPE
------	---------	------	------



Seamlessly bringing together lighting and acoustical sound control into one configurable system. Perfect for open ceiling or tall spaces to control sound and provide lighting in one fixture.

### FEATURES

- Direct/Indirect Lighting
- NRC (Noise Reduction Coefficient): of .75
- Acoustical Felt (99% Recycled Content) is Available in 17 Colors Standard
- Available In Made To Measure Lengths Accurate Up To 1/16"
- CRI 90+ Standard; R9>50
- 5 Year, 50,000 Hour Fixture Warranty
- 2700K, 3000K, 3500K, 4000K & 5000K Color Temperatures Available
- Available with PoE

<b>APPLICATIONS</b>	Commerical Interiors, Open Offices, Retail, Hospitality, Reception Areas & Corridors		
<b>CONSTRUCTION</b>	FIXTURE: Aluminum Housing with Die Cast Ends. Steel Gear Tray. BAFFLE: 99% Recycled Polyester Felt	<b>OPTICS</b>	Extruded High Transmission Satin Acrylic Lens with No LED Imaging. Additional Optics Available
<b>WARRANTY</b>	5 Year Limited Warranty (Covers Standard Components)	<b>FINISH</b>	FIXTURE: Standard Powder-Coated White. Custom RAL Colors Available. BAFFLE: See Page 3
<b>FIXTURE RATINGS &amp; CERTIFICATIONS</b>	Union Made ETL Listed	Made In The USA Damp Location Rated	 
<b>ELECTRICAL</b>	Integral Driver with 0-10V Dimming Standard. Several Driver Options Available		<b>DRIVERS &amp; SENSORS</b> 
			For Wiring Diagrams and Sensor Information Click <a href="#">Here</a>

### EXTRUSION DIMENSIONS

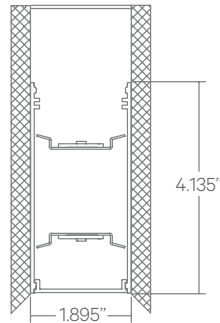

### LED SYSTEM INFORMATION

	Nominal System Watts		Nominal Delivered Lumens	
	DIRECT	INDIRECT	DIRECT	INDIRECT
Standard (LTG1)	7.5 W/ft	7.5 W/ft	475 lm/ft	250 lm/ft
Low (LTG2)	5.25 W/ft	5.25 W/ft	355 lm/ft	200 lm/ft
High (LTG3)	9 W/ft	9 W/ft	641 lm/ft	300 lm/ft

Based on a 3500K luminaire using one driver. Custom outputs available; specify below.

<b>ORDERING</b>	1	2	3	IN -	D -	5	6	7	8	9	10	11
				4-INDIRECT	4-DIRECT							

1 - FIXTURE ID	2 - LENGTH	3 - COLOR TEMP	4 - LED SYSTEM		5 - VOLTAGE	6 - DRIVER
LS1 UPDN STFU	2 - 2 ft 4 - 4 ft 8 - 8 ft X'-X" - Specify Length	27 - 2700K/90 CRI 30 - 3000K/90 CRI 35 - 3500K/90 CRI 40 - 4000K/90 CRI 50 - 5000K/90 CRI TW* - Tunable White RGBW** - RGB + 3000K *Must use DMX or TW10 Driver **Must use DMX Driver	<b>IN - INDIRECT</b> LTG1 - Standard LTG2 - Low LTG3 - High LTGC - Custom Output	<b>D - DIRECT</b> LTG1 - Standard LTG2 - Low LTG3 - High LTGC - Custom Output	UNV - Universal (120/277V)	DB - Standard Dimming (0-10V) DB1% - 1% Dimming (0-10V) DB.1% - 0.1% Dimming (0-10V) LTEA - Lutron 2-wire 1% Dimming (120V only) LDE1 - Lutron Digital EcoSystem LDE5 - 5 Series EcoSystem; 5% Dimming PoE - Power over Ethernet. Consult Factory for Compatibility DMX - For Color Tuning and RGBW (Remote) TW10 - Dual Channel, 0-10V For Color Tuning (CCT and Intensity Control)

7 - FINISH (Fixture)	8 - FINISH (Baffle)	9 - MOUNTING	10 - CONTROL (Optional)	11 - OTHER OPTIONS
W - White (Standard) BLK* - Black CC* - Custom Color (provide RAL#) *White cord and canopy provided. Must specify for other requests.	01 - Cream 04 - Light Gray 06 - Charcoal 07 - Black 48 - Light Brown *NOTE: More colors available. See page 3	ACC - Air Craft Cable To Canopy ACU - Air Craft Cable To Unistrut Channel	EIS - Enlighted Sensor WISD - Wattstopper Daylight Sensor WISM - Wattstopper Occupancy Sensor SLS - SensiLUM Sensor ACS - Acuity Controls nLight System CCS - Casambi Compatible ECS - Eaton WaveLinx System *For other control systems not listed consult factory.	DC - Dual Circuit (Separate Up/Dn Control) EM 120V - Emergency Pack EM 277V - Emergency Pack EMCKT - Emergency Circuit

### MOUNTING OPTIONS

**ACC** - Air Craft Cable Mounting (50") to Canopy

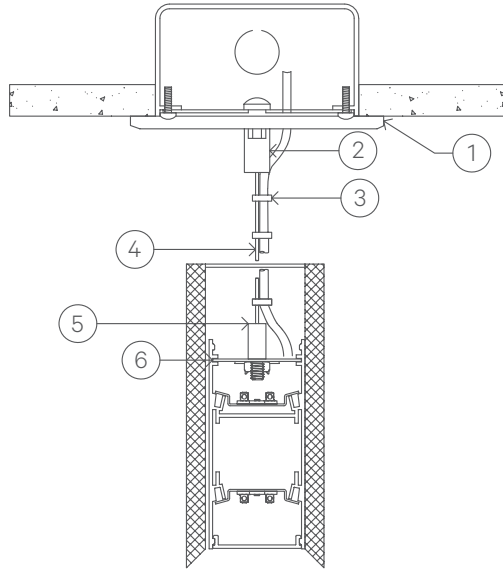

- 1 - 5" Round Canopy (Standard White Finish)
- 2 - Canopy Retainer
- 3 - SJT Cord (Standard White)
- 4 - Air Craft Cable
- 5 - Gripper
- 6 - Hanging Bracket

**ACU** - Air Craft Cable Mounting (50") to Unistrut Channel

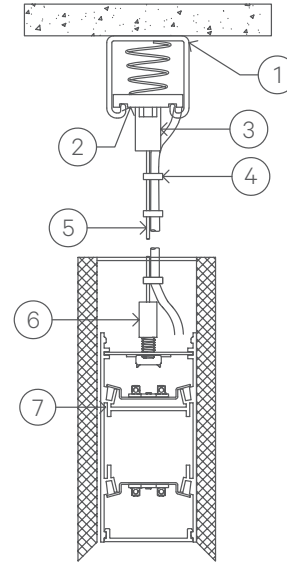

- 1 - Unistrut Channel
- 2 - Stud Nut
- 3 - Cable Retainer
- 4 - SJT Cord (Standard White)
- 5 - Air Craft Cable
- 6 - Gripper
- 7 - Hanging Bracket

DATE

PROJECT

FIRM

TYPE

### BAFFLE/FELT COLORS

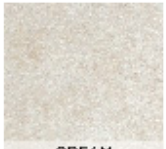

CREAM



LIGHT GREY

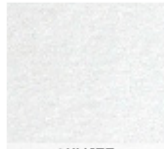

WHITE



CHARCOAL



BLACK

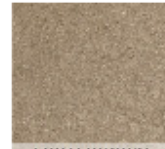

LIGHT BROWN



GREEN



RED



MAROON



LIGHT BLUE



DARK BLUE



MATT GREY



BROWN

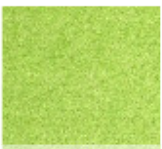

LIME



LAVENDER



ORANGE



YELLOW