

Rush Sharp indirect/direct

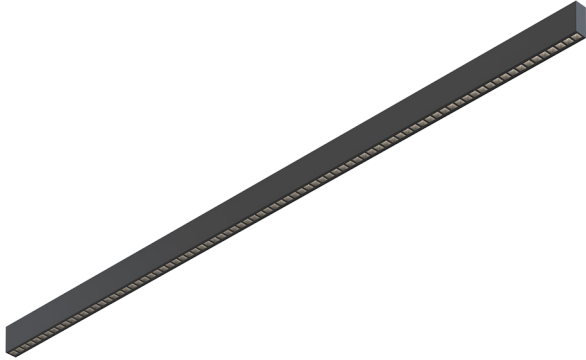

The Sharp Series of architectural luminaires features slim profiles, glare free, beam shaping optical cells and several mounting options. Custom lengths are tailored to suit any modern space.

Features

- Power over aircraft cable system
- Extruded recycled aluminum housing
- Aluminum core LED boards, specifiable output
- Specifiable color temperature. CRI > 90, R9 >50
- Custom lengths, welded patterns, and finishes available
- Specifiable dimmable drivers or PoE
- 5 Year, 50,000 hour warranty
- WELL Building Standard compatible [learn more](#)

Dimensions

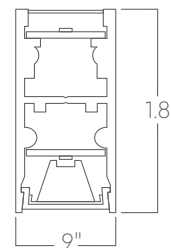

baffle wide

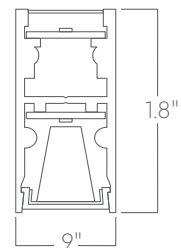

baffle narrow

Optics

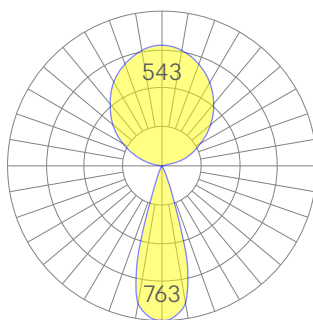

low

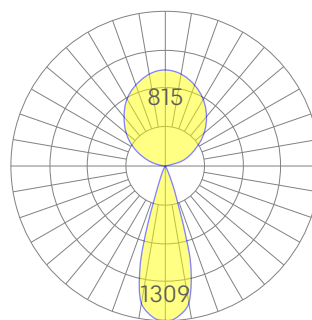

medium

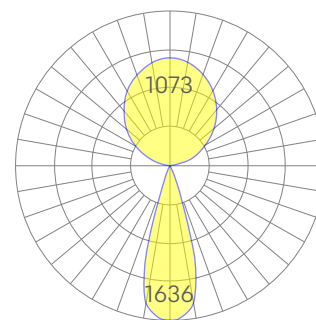

high

Representative distribution and peak candela. For other options see order information or IES files [here](#).

Rush Sharp indirect/direct

Ordering Information



Example: RUSH SHARP - 8 - 35 - MED - MED - UNV - DB - W - W - AC - SD - SD - CCS - DAYCKT - NA

Fixture ID <input type="text" value="1"/>	Length <input type="text" value="2"/>	Color Temperature <input type="text" value="3"/>	Output <input type="text" value="4a-"/> <input type="text" value="4b-"/>	
RUSH SHARP	2 2 ft 4 4 ft 8 8 ft X'X" Specify Length	27 2700K/90 CRI 30 3000K/90 CRI 35 3500K/90 CRI 40 4000K/90 CRI	4a - Indirect LOW Low output MED Medium output HIGH High output CUST Custom output ¹ 4b - Direct LOW Low output MED Medium output HIGH High output CUST Custom output ¹	
<small>¹Custom lengths available in 1ft nominal increments</small>				
Voltage <input type="text" value="5"/>	Driver <input type="text" value="6"/>	Finish <input type="text" value="7a-"/> <input type="text" value="7b-"/>	Mounting <input type="text" value="8"/>	
UNV 347V Universal (120/277V) 347V	DB Standard 0-10V 1% DB.1% 0-10V 0.1% ELV 2-wire 1% (120V only) TRI Forward phase (120V only) LDE1 Lutron Digital EcoSystem DALI DALI-2 Driver PoE Power over Ethernet. DMX DMX512	7a - Housing W White BLK Black CC Custom Color 7b - Louver W White BLK Black	ACP Power Over Aircraft Cable AC Aircraft Cable (50") WM Wall Mount	
<small>¹Set to default address 001. RDM capable. Contact us for other addressing needs.</small>				
<small>*Must use DB Driver</small>				
<small>All drivers remote</small>				
<small>¹Custom Color. See finish options here.</small>				
<small>White SJ cord and canopy provided, for other requests, see section 12 to specify.</small>				
<small>ACP provided. Must specify for other</small>				
Optics <input type="text" value="9a-"/> <input type="text" value="9b-"/>	Sensors/Controls <input type="text" value="10"/>	Circuit <input type="text" value="11"/>	Options <input type="text" value="12"/>	
7a - Indirect SD Standard Diffuser 7b - Direct BNB Baffle Narrow - Black (36° Beam Spread) BWB Baffle Wide - Black (62° Beam Spread) BNW Baffle Narrow - White (40° Beam Spread) BWW Baffle Wide - White (65° Beam Spread)	NA None ACM Acuity nLight Module Only CCS Casambi Module	NA None EM120V Emergency Pack EM277V Emergency Pack EMCKT Emergency Circuit DAYCKT Daylight Circuit	NA None CAN-X Canopy + color SJ-X² SJ Cord + color	
<small>Consult factory for other options.</small>				
<small>¹White SJ cord and canopy provided, use above nomenclature for other requests.</small>				
<small>²See finish options here</small>				

Performance

Output ¹	indirect		direct	
	Watts/ft	Lumens/ft	Watts/ft	Lumens/ft
Low	4	340	4	247
Medium	6	510	6	423
High	8	670	8	528

¹Based on a typically configured 90 CRI, 3500K luminaire using one driver.

Custom outputs available. Please consult factory.
For 4000K multiply by 1.05, for 3000K 0.9, for 2700K, 0.92

Technical Information



click [here](#) or scan QR code

Wiring diagrams, PoE and sensor details

Modification date: November, 2021

Rush Sharp indirect/direct

Drivers & Electrical

Remote, dimmable drivers are supplied in enclosures.

Emergency Back-Up

For fixtures three-feet or longer, a 4W integral emergency driver may be wired to 4ft sections. 7W, 10W, and 12W drivers are also available (not all integral; consult factory). Emergency circuits for use with building generators are also available.

PoE (Power over Ethernet)

Compatible with virtually all PoE systems including Molex Coresync, Igor, Smartengine, Platformatics, and NuLED SPICEbox. Consult Factory for systems not listed, See [here](#) for more info.

Finishes

All luminaires are finished in high quality polyester powder coating. Our standard color is white. Any RAL color may be specified.

Weight

3 lbs per foot

Patterns

Featuring illuminated welded corners and angles. Consult factory for custom designs.

Optics

Glare free, beam shaping optical cells.

Construction

Extruded, recycled aluminum housing with formed steel ends.

Joined runs

Runs of any length may be specified and are comprised of multiple, factory-engineered, joined sections. Individually specified luminaires are not field joinable.

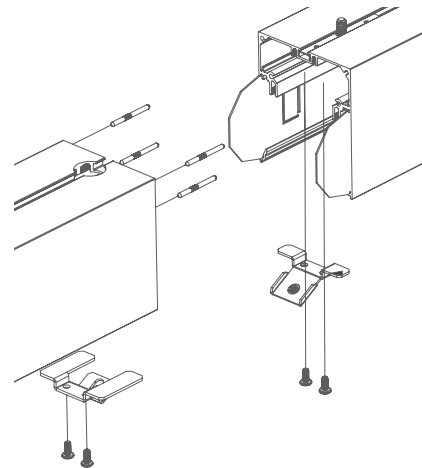

Representative joinery. For product specific details see installation guides or submittal drawings.

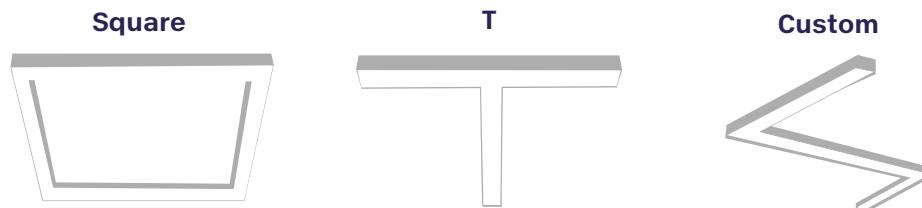

Rush Sharp indirect/direct

Mounting Options

Custom mounting types and ceiling transitions available; consult factory.

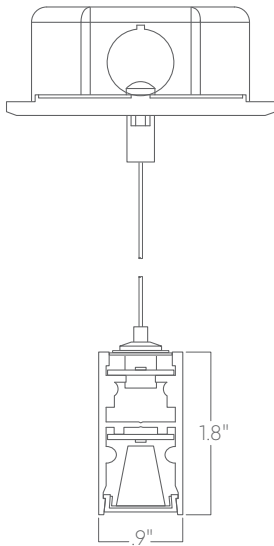

Power over aircraft cable

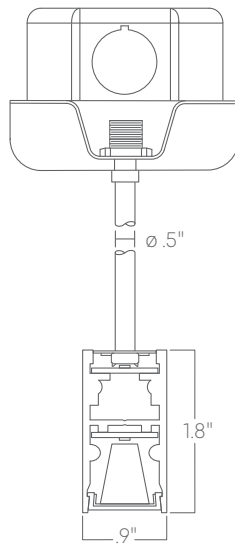

Pendant stem

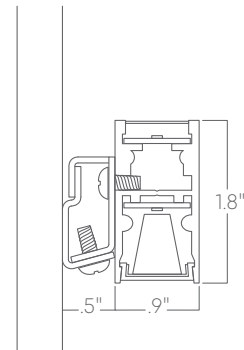

Wall mount