

Rush Sharp direct

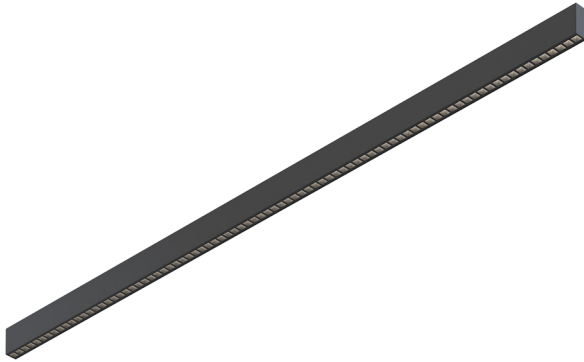

The Sharp Series of architectural luminaires features slim profiles, glare free, beam shaping optical cells and several mounting options. Custom lengths are tailored to suit any modern space.

Features

- Power over aircraft cable system
- Extruded recycled aluminum housing
- Aluminum core LED boards, specifiable output
- Specifiable color temperature. CRI > 90, R9 >50
- Custom lengths, welded patterns, and custom finishes available
- Specifiable dimmable drivers or PoE
- 5 Year, 50,000 hour warranty, damp location rated
- WELL Building Standard compatible [learn more](#)

Dimensions

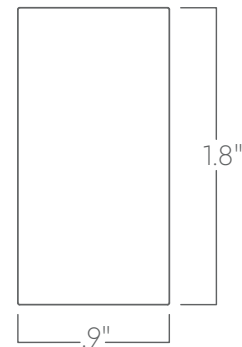

Optics

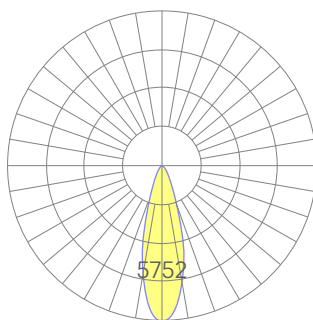

spot

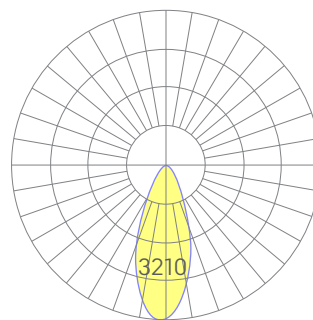

flood

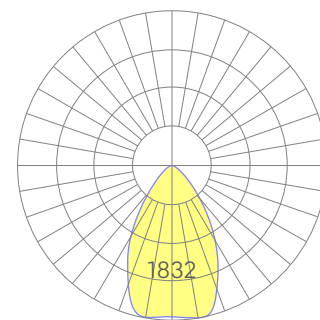

wide flood

Representative distribution and peak candela. For other options see order information or IES files [here](#).

Rush Sharp direct

Ordering Information



Example: RUSH SHARP - 8 - 35 - MED - UNV - DB - W - BLK - ACP - WFL - CCS - DAYCKT - NA

Fixture ID <input type="text" value="1"/>	Length <input type="text" value="2"/>	Color Temperature <input type="text" value="3"/>	Output <input type="text" value="4"/>
RUSH SHARP	2 2 ft 4 4 ft 8 8 ft X'X" Specify length ¹ PAT Pattern (Consult Factory) <small>¹Custom lengths in 4.25" increments All lengths are nominal unless specified to be exact.</small>	27 2700K/90 CRI 30 3000K/90 CRI 35 3500K/90 CRI 40 4000K/90 CRI	LOW Low output MED Medium output HIGH High output CUST Custom output ¹ <small>¹consult factory</small>
Voltage <input type="text" value="5"/>	Driver <input type="text" value="6"/>	Finish <input type="text" value="7a-"/> <input type="text" value="7b-"/>	Mounting <input type="text" value="8"/>
UNV Universal (120/277V) 347V¹ 347V	DB Standard 0-10V 1% DB.1% 0-10V 0.1% ELV² Reverse Phase 1% (120V only) TRI² Forward phase (120V only) DALI DALI-2 Driver DMX¹ DMX512 <small>¹Set to default address 001. Contact us for other addressing needs. ²For compatible dimmers, click here. All drivers remote</small>	7a - Housing W White BLK Black CC¹ Custom Color 7b - Louver W White BLK Black <small>¹Custom Color. See finish options here. White SI cord and canopy provided; for other requests, see section 12 to specify.</small>	ACP Power Over Aircraft Cable ACP3.5 3.5" canopy + jbox adaptor ¹ SM Surface Mount <small>¹Adaptor must be mudded-in. White stems and canopy provided unless otherwise specified in options (section 12).</small>
Optics <input type="text" value="9"/>	Sensors/Controls <input type="text" value="10"/>	Circuit <input type="text" value="11"/>	Options <input type="text" value="12"/>
SP 24° Beam FL 36° Beam WFL 55° Beam	NA None ACM Acuity nLight Module Only CCS Casambi Module AWNRR Lutron Athena Wireless Node Module <small>All control systems are remote. Consult factory for other options.</small>	NA None EMPCK Emergency Battery Pack EMCKT Emergency Circuit DAYCKT Daylight Circuit	STD White Canopy + ACP ² CAN-X¹ Canopy + color + ACP ² <small>¹See finish options here. ²Power over wire cable color is not customizable.</small>

Performance

Output ¹	Watts/ft	Lumens/ft
Low	4	312
Medium	6	469
High	8	625

¹Based on 'WFL' option, black louver, 90 CRI, 3500K luminaire using one driver.

Custom outputs available. Please consult factory.
For 4000K multiply by 1.05; for 3000K 0.96; for 2700K, 0.92

Technical Information



click [here](#) or scan QR code

Wiring diagrams, PoE and sensor details

Modification date: June,2023

Page 2 of 4

Rush Sharp direct

Drivers & Electrical

Remote, dimmable drivers are supplied in enclosures. For remote driver box sizes, click [here](#).

Emergency Back-Up

For fixtures three-feet or longer, a 4W remote emergency driver may be wired to 4ft sections. 7W, 10W, and 12W drivers are also available. Emergency circuits for use with building generators are also available.

Finishes

All luminaires are finished in high quality polyester powder coating. Our standard color is white. Any RAL color may be specified.

Weight

1 lb per foot

Optics

Glare free, beam-controlling TIR optics.

Construction

Extruded, recycled aluminum housing with formed cast ends.

Joined runs

Runs of any length* may be specified and are comprised of multiple, factory-engineered, joined sections. Individually specified luminaires are not field joinable.

*Custom lengths available in 12" nominal increments

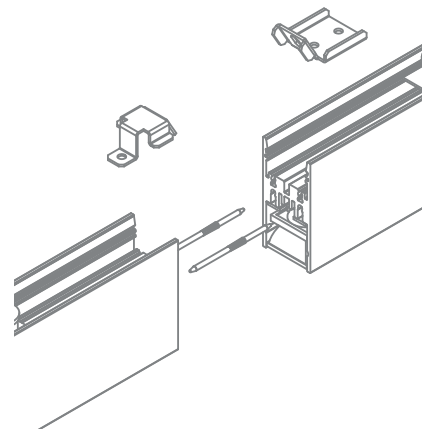

Representative joinery. For product specific details see installation guides or submittal drawings.

Patterns

Featuring illuminated welded corners and angles. Consult factory for custom designs and elevations.

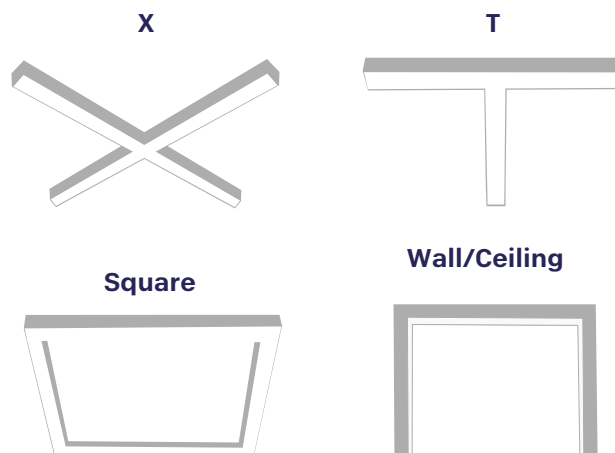

Rush Sharp direct

Mounting Options

Custom mounting types and ceiling transitions available; consult factory.

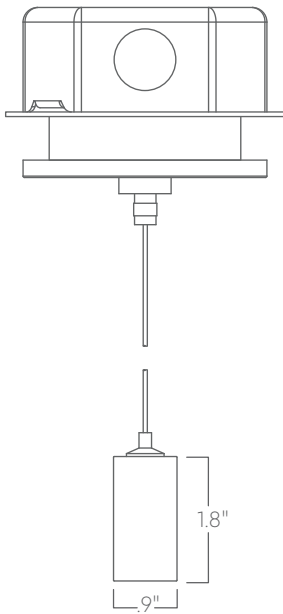

**Power over
Aircraft Cable
3.5" canopy**

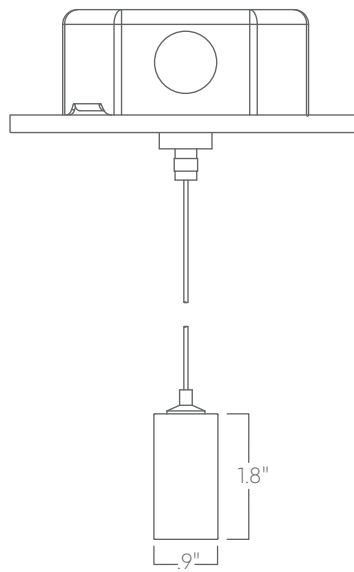

**Power over
Aircraft Cable
5" canopy**

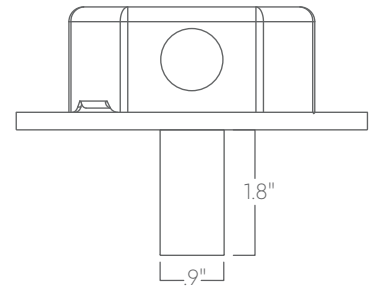

Surface mount