

LSR4 MR recessed

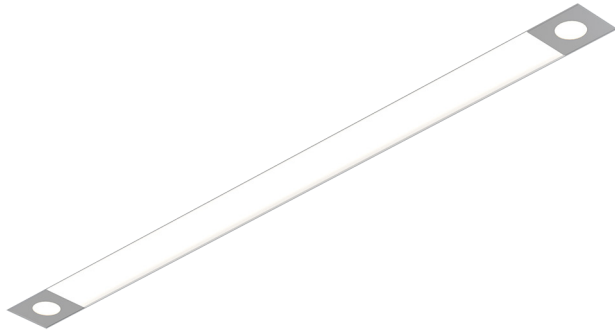

The LS Series of architectural luminaires offers a wide range of profiles and mounting options. Custom lengths and patterns are tailored to suit any modern space.

Features

- Extruded recycled aluminum housing
- Aluminum core LED boards, specifiable optics
- Specifiable color temperature. CRI > 90, R9 >50
- Custom lengths, welded patterns, and finishes available
- Integral specifiable dimmable drivers or PoE
- 5 Year, 50,000 hour warranty
- WELL Building Standard compatible [learn more](#)

Dimensions

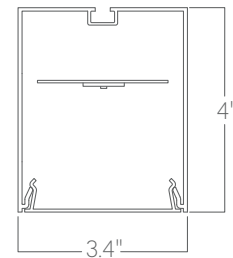

Optics

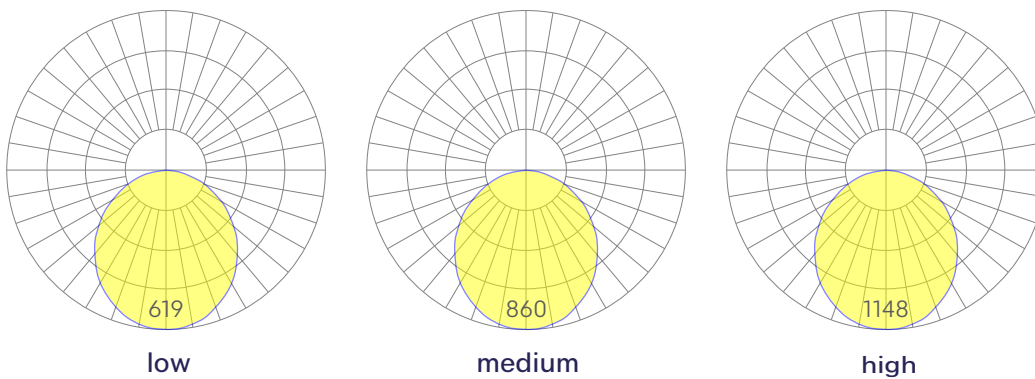

Representative distribution and peak candela. For other options see order information or IES files [here](#).

LSR4 MR recessed

Ordering Information



Example: LSR4 MR - 8 - 35 - MED - UNV - DB - W - AC - SD - CCS - DAYCKT - NA

Fixture ID <input type="text" value="1"/>	Length <input type="text" value="2"/>	Color Temperature <input type="text" value="3"/>	Output <input type="text" value="4"/>
LSR4 MR	2 2 ft 4 4 ft 8 8 ft X'-X" Specify Length ¹ PAT Pattern (Consult Factory)	27 2700K/90 CRI 30 3000K/90 CRI 35 3500K/90 CRI 40 4000K/90 CRI 50 5000K/90 CRI WD ¹ Warm Dim 2200K-3000K TW ² Tunable white 2700K-6500K RGBW30 ³ RGB +white, 3000k RGBW35 ³ RGB +white, 3500k RGBW40 ³ RGB +white, 4000k	LOW Low output MED Medium output HIGH High output CUST Custom output ¹
Voltage <input type="text" value="5"/>	Driver <input type="text" value="6"/>	Finish <input type="text" value="7"/>	Mounting <input type="text" value="8"/>
UNV Universal (120/277V) 347V 347V	DB Standard 0-10V 1% DB.1% 0-10V 0.1% ELV 2-wire 1% (120V only) TRI Forward phase (120V only) LDE1 Lutron Digital EcoSystem JA8 JA8 compliant 1% dimming DALI DALI-2 Driver PoE Power over ethernet. TW10 Dual channel, 0-10V for tunable white. WD10 0-10V Warm Dim PSQ Lutron T-Series 2-channel 1% for tunable white DMX ¹ DMX512	W White BLK Black CC ¹ Custom Color CWF ¹ Custom Wood Finish	T 9/16" Tee Grid T15 15/16" Tee Grid SG Slot Grid/Interlude F Flange NT Mud-in Flange PM-X Perimeter Mount MW ² Millwork
Optics <input type="text" value="9"/>	Sensors/Controls <input type="text" value="10"/>	Circuit <input type="text" value="11"/>	Options <input type="text" value="12"/>
SD Standard Diffuser WW Wall Wash Reflector	NA None EIS Enlighted sensor WISM Wattstopper occupancy sensor WISD Wattstopper daylight sensor ECS Eaton WaveLinX sensor ACM Acuity nLight module only ACS Acuity nLight sensor CCS Casambi module	NA None EM120V Emergency Pack EM277V Emergency Pack EMCKT Emergency Circuit DAYCKT Daylight Circuit	10° STD 10° standard beam MR 25° CRC 25° circular beam MR 36° CRC 36° circular beam MR 60° CRC 60° circular beam MR 60° LNR 60° linear beam MR HEX hexcell louver (can add to any beam spread)

Performance

Output ¹	Watts/ft	Lumens/ft
Low	5	425
Medium	7	590
High	10	788

¹Based on a typically configured 90 CRI, 3500K luminaire using one driver.

Custom outputs available. Please consult factory.
For 4000K multiply by 105, for 3000K 0.9%, for 2700K, 0.92.

Technical Information



click [here](#) or scan QR code

Wiring diagrams, PoE and sensor details

Modification date: October, 2021

LSR4 MR recessed

Drivers & Electrical

Integral drivers* with 0-10V Dimming standard. Several other driver options available; see ordering information.

*DMX drivers are provided in remote enclosures.

Sensors & Controls

Sensors are installed on an aluminum plate adjacent to the luminaire lens. Coronet remains agnostic in our approach to sensors and control systems; our fixtures are compatible with most systems offered.

*Not applicable to indirect only models. Consult factory.

Emergency Back-Up

For fixtures three-feet or longer, a 4W integral emergency driver may be wired to 4ft sections. 7W, 10W, and 12W drivers are also available (not all integral; consult factory). Emergency circuits for use with building generators are also available.

PoE (Power over Ethernet)

Compatible with virtually all PoE systems including Moxel Coresync, Igor, Smartengine, Platformatics, and NuLED SPICEbox. Consult Factory for systems not listed, See [here](#) for more info.

Finishes

All luminaires are finished in high quality polyester powder coating. Our standard color is white. Any RAL color may be specified.

Weight

5 lbs per foot

Patterns

Featuring illuminated welded corners and angles. Consult factory for custom designs.

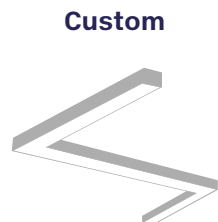
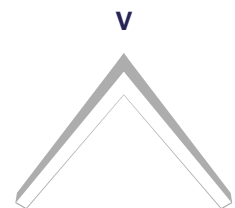
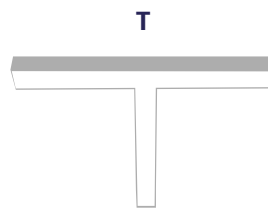
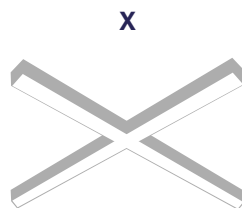
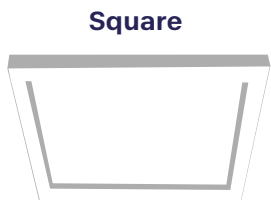

Optics

Extruded satin acrylic lenses provide excellent diffusion, high transmission, and no LED imaging.

Construction

Housings are extruded premium, recycled aluminum. Individual fixtures are available up to 12' long and may be specified as nominal or precision lengths. Precision lengths are supplied within 1/8" tolerance.

Joined Runs

Runs of any length may be specified and are comprised of multiple, factory-engineered, joined sections. Individually specified luminaires are not field joinable.

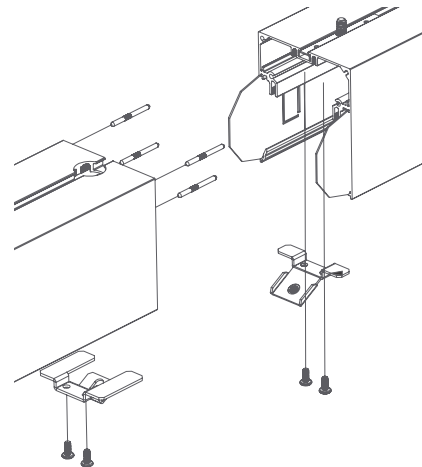

Representative joinery. For product specific details see installation guides or submittal drawings.

LSR4 MR recessed

Mounting Options

Custom mounting types and ceiling transitions available; consult factory.

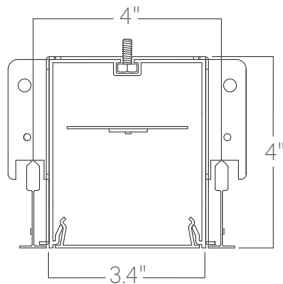

T
9/16" tee grid

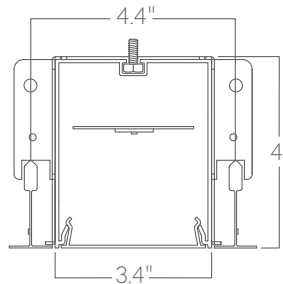

T15
15/16" tee grid

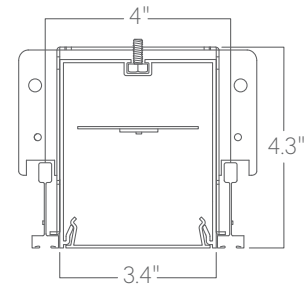

SG
slot grid

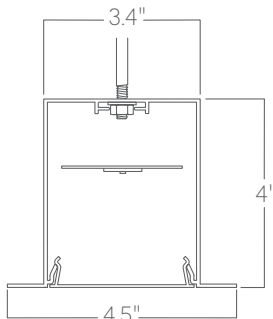

F
flange

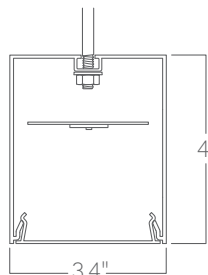

MW
millwork

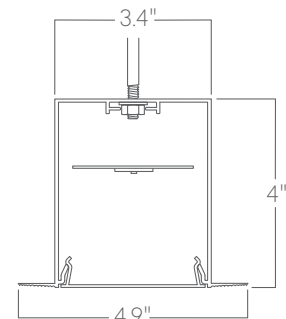

NT
mud-in

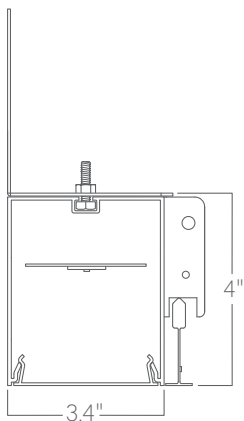

PM-T
perimeter to 9/16" tee grid

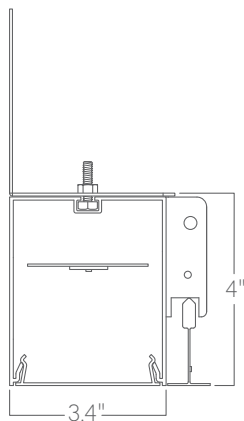

PM-T15
perimeter to 15/16" tee grid

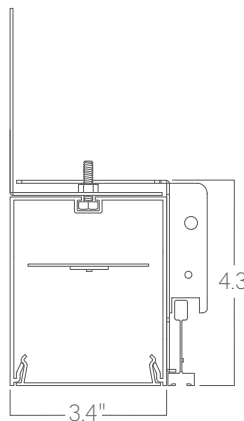

PM-SG
perimeter to slot grid

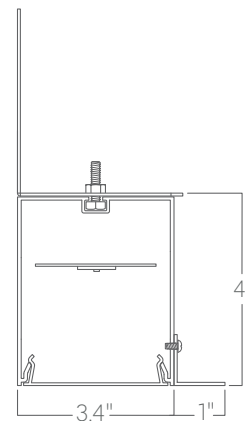

PM-F
perimeter to flange

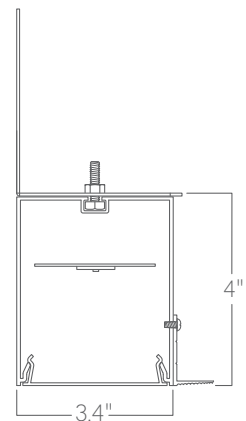

PM-NT
perimeter to mud-in