

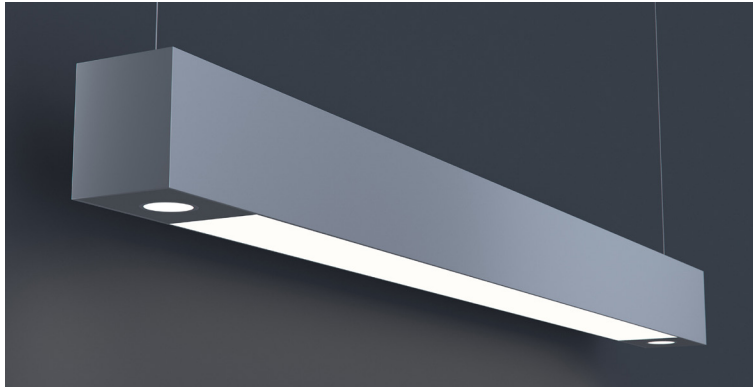

DATE	PROJECT	FIRM	TYPE
------	---------	------	------



Linear, architectural luminaire with accent downlighting. Suitable for suspended, surface or wall mount installation. For custom mounting consult factory.

### FEATURES

- Available In Custom Lengths & Long Runs To 1/16" Accuracy
- Corners & Patterns Available (See Page 2)
- Damp Location Rated
- CRI 90+ Standard
- 5 Year, 50,000 Hour Fixture Warranty
- 2700K, 3000K, 3500K, 4000K & 5000K Color Temperatures Available
- Enlighted/Wattstopper Sensors Available

<b>APPLICATIONS</b>	Offices, Lobbies, Retail Stores, Classrooms, Reception Areas & Corridors			
<b>CONSTRUCTION</b>	Extruded Aluminum Housing, Steel End Caps, Formed Steel Gear Tray	<b>OPTICS</b>	Extruded High Transmission Satin Acrylic Lens With No LED Imaging. Accent Lighting Varies (See Page 3)	
<b>WARRANTY</b>	5 Year Limited Warranty (Covers Standard Components)		<b>FINISH</b>	Standard Powder-Coated White. Custom RAL Colors Available
<b>FIXTURE RATINGS &amp; CERTIFICATIONS</b>	Union Made ETL Listed	Made In The USA Damp Location Rated	 	

<b>ELECTRICAL</b>	Integral Driver With 0-10V 10% Dimming Standard. Several Driver Options Available. See Below For Lutron Dimming Information		
	2-Wire Forward Phase; Hi-Lume 1% Dimming, Only Available For 120V		LTEA
	3-Wire EcoSystem; Hi-lume 1% Dimming		L3DA
	Digital EcoSystem; Hi-lume 1% Dimming, 'Soft-on Fade-to-black' (Required for Daylighting)		LDE1
	5 Series EcoSystem; 5% Dimming		LDE5

### EXTRUSION DIMENSIONS

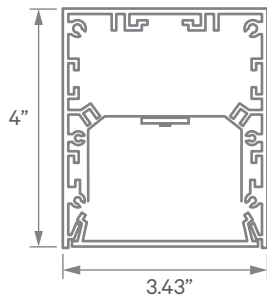

### LED SYSTEM INFORMATION

	Nominal System Watts	Nominal Delivered Lumens	Nominal Efficacy
Standard (LTG1)	40 W	3,050 Lm	76 Lm/W
Low (LTG2)	33W	2,525 Lm	77 Lm/W
High (LTG3)	48W	3,500 Lm	73 Lm/W

Based on a 4ft, 3500K luminaire using one driver and (2) standard 10° MR16 lamps. Output varies depending on beam spread. Additional photometric information available. Please consult factory for custom lumen outputs & wattage.

<b>ORDERING</b>											
	1	2	3	4	5	6	7	8	9	10	11
<b>1 - FIXTURE ID</b>	<b>2 - LENGTH</b>		<b>3 - COLOR TEMP</b>		<b>4 - LED SYSTEM</b>		<b>5 - VOLTAGE</b>		<b>6 - DRIVER</b>		<b>7 - FINISH</b>
LS4 MR16 LED	2 - 2 ft 4 - 4 ft 8 - 8 ft x'-x" - Custom (specify length)		27 - 2700K/90 CRI 30 - 3000K/90 CRI 35 - 3500K/90 CRI 40 - 4000K/90 CRI 50 - 5000K/90 CRI TW* - Tunable White RGBW* - RGB + 3000K		LTG1 - Standard LTG2 - Low LTG3 - High C - Custom Output (ie-C550Lm/ft)		UNV - Universal (120/277V)		DB - Standard 10% Dimming (0-10V) DB1% - 1% Dimming (0-10V) DB.01% - .01% Dimming (0-10V) LTEA* - Lutron 2-wire 1% Dimming L3DA* - Lutron 3-wire 1% Dimming LDE1* - Lutron Digital EcoSystem LDE5* - EcoSystem; 5% Dimming *Refer to 'Electrical' Information Above DMX - For Color Tuning and RGBW		W - White (Standard) CC - Custom Color (provide RAL#)
**Patterns available, consult factory			*Must use DMX Driver (Remote)								
<b>8 - MOUNTING</b>	<b>9 - CONTROL</b>		<b>10 - OPTICS</b>		<b>11 - OPTIONS</b>		<b>12 - ACCENT LIGHTING (See Page 3)</b>				
AC - Air Craft Cable (50" Standard) SM - Surface Mount WM - Wall Mount	EIS - Integral Sensor by Enlighted WIS - Integral Sensor by Wattstopper		SD - Standard Diffuser		WW - Wall Wash Reflector EM 120V - Emergency Pack EM 277V - Emergency Pack		10° STD - 10° Standard 25° CRC - 25° Circular 36° CRC - 36° Circular 60° CRC - 60° Circular 25° LNR - 10° x 25° Linear 36° LNR - 10° x 36° Linear 60° LNR - 10° x 60° Linear HEX - Hexcell Louver (can add to any beam spread)				

DATE

PROJECT

FIRM

TYPE

## MOUNTING OPTIONS

### AC - Air Craft Cable (50")

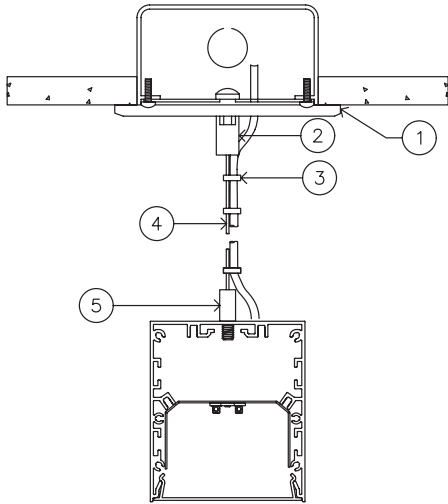

- 1 - 5" Round Canopy (Standard White Finish)
- 2 - Canopy Retainer
- 3 - SJT Cord (Standard White)
- 4 - Air Craft Cable
- 5 - Gripper

### SM - Surface Mount

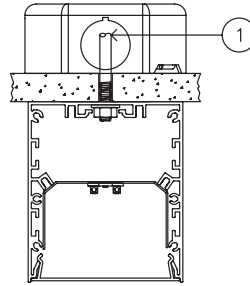

- 1 - Threaded Rod (not supplied)

### WM - Wall Mount

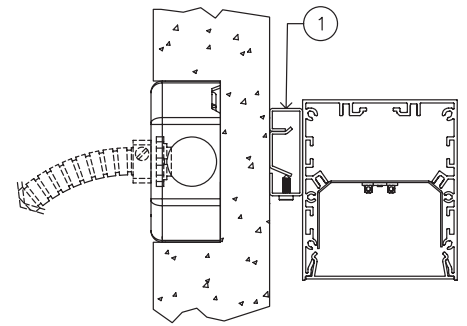

- 1 - 0.75" Wall Mount Bracket

## CORNERS & PATTERNS

Available with illuminated corners, angles, and custom patterns. **Must consult factory for custom corners and patterns.**

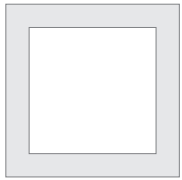

Square Patterns

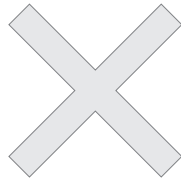

X Patterns

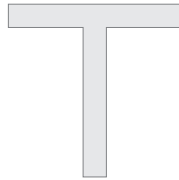

T Patterns

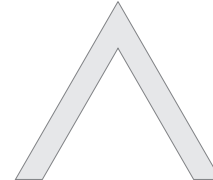

Custom Angles

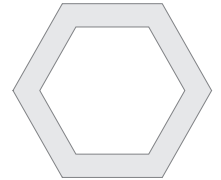

Custom Patterns

## LENS CUT OPTIONS

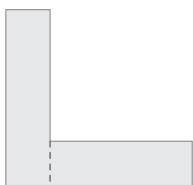

Straight-cut

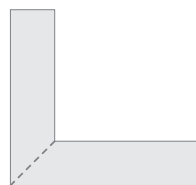

Mitered Angle

NOTE: Straight-Cut is standard configuration, Mitered Angle is optional and must be specified.

DATE	PROJECT	FIRM	TYPE
------	---------	------	------

### ACCENT DOWNLIGHT INFORMATION

SORAA MR16, 95CRI lamps provided with optional filters for flexible beam spread. Please note that when choosing 3500k color temperature a 4000k lamp with color correcting filter will be supplied.

### OPTIONAL BEAM SPREADS AND FILTERS

- 10° Standard Lens
- 25° Circular Beam Spread\*
- 36° Circular Beam Spread\*
- 60° Circular Beam Spread\*
- 10° x 25° Linear Beam Spread\*
- 10° x 36° Linear Beam Spread\*
- 10° x 60° Linear Beam Spread\*
- Hexcell Louver for Reduced Glare (can be added to any beam spread)\*

\*Standard 10° SORAA lamp supplied with specially designed snap-in filter to create requested beam spread.

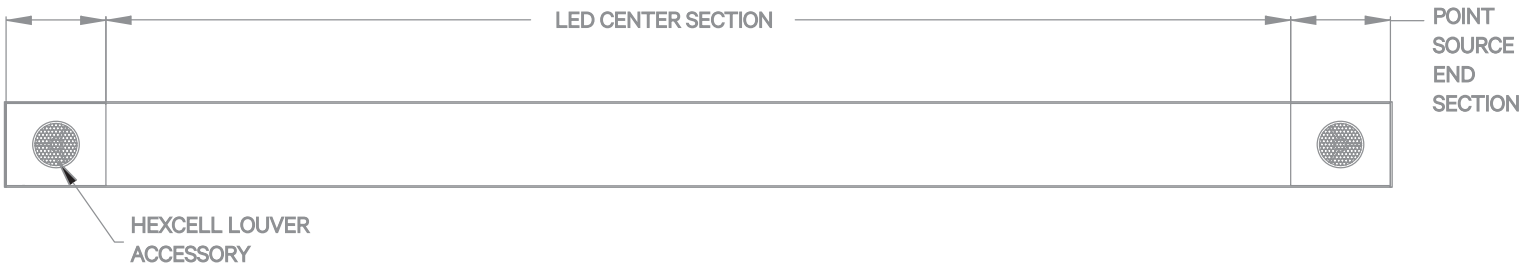
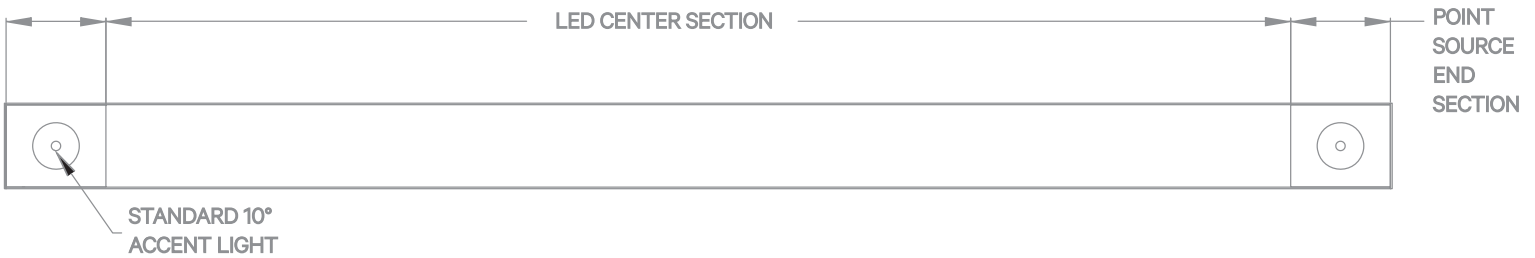

Please Note: On an individual fixture accent lights are placed on either end of the unit. For continuous runs, accent lights are placed every 8 feet. Consult Factory for alternative placement. Fixture must be a minimum of 4 feet.