

# Loop 3ft direct

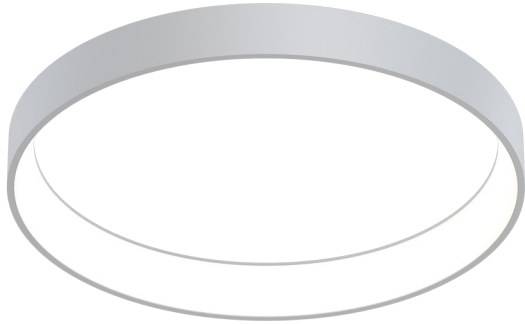

Our Performance Decorative luminaires offer a variety of decorative forms and sizes suitable for any modern space.

## Features

- Power Over Wire system eliminates power cord
- Indirect and direct light distribution
- Cold-rolled steel housing
- Specifiable color temperature. CRI > 90, R9 >50
- Custom colors and wood finishes finishes available
- Specifiable dimmable drivers or PoE
- 5 Year, 50,000 hour warranty
- WELL Building Standard compatible [learn more](#)

## Dimensions

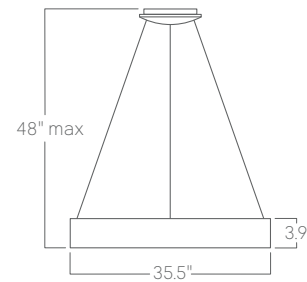

## Optics

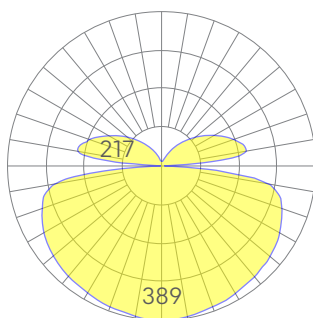

low

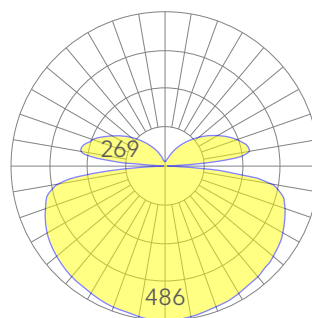

medium

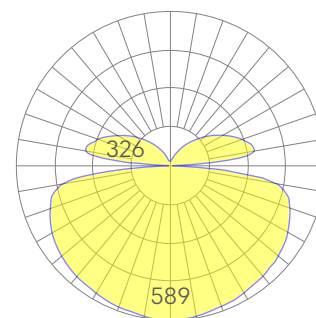

high

Representative distribution and peak candela. For other options see order information or IES files [here](#).

# Loop 3ft direct

## Ordering Information



Example: LOOP - 8 - 35 - MED - UNV - DB - W - AC - SD - CCS - DAYCKT - NA

<b>Fixture ID</b> <input type="text" value="1"/>	<b>Length</b> <input type="text" value="2"/>	<b>Color Temperature</b> <input type="text" value="3"/>	<b>Output</b> <input type="text" value="4"/>
<b>LOOP</b>	<b>3</b> 3 ft	<b>27</b> 2700K/90 CRI <b>30</b> 3000K/90 CRI <b>35</b> 3500K/90 CRI <b>40</b> 4000K/90 CRI <b>50</b> 5000K/90 CRI	<b>LOW</b> Low output <b>MED</b> Medium output <b>HIGH</b> High output <b>CUST</b> Custom output <sup>1</sup>
<b>Voltage</b> <input type="text" value="5"/>	<b>Driver</b> <input type="text" value="6"/>	<b>Finish</b> <input type="text" value="7"/>	<b>Mounting</b> <input type="text" value="8"/>
<b>UNV</b> Universal (120/277V) <b>347V<sup>1</sup></b> 347V	<b>DB<sup>1</sup></b> Standard 0-10V 1% <b>DB.1%<sup>2</sup></b> 0-10V 0.1% <b>PoE<sup>3</sup></b> Power over Ethernet	<b>W</b> White <b>BLK</b> Black <b>CC<sup>1</sup></b> Custom Color <b>CWF<sup>1</sup></b> Custom Wood Finish	<b>ACP</b> Power Over Aircraft Cable <b>SM</b> Surface Mount
<small><sup>1</sup>Driver housed in canopy <sup>2</sup>Driver housed in remote enclosure. <sup>3</sup>Housing varies. Consult factory</small>	<small><sup>1</sup>Custom Color. See finish options here. White SJ cord and canopy provided, for other requests, see section 12 to specify.</small>	<small>White canopy provided. Must specify other requests.</small>	
<b>Optics</b> <input type="text" value="9"/>	<b>Sensors/Controls</b> <input type="text" value="10"/>	<b>Circuit</b> <input type="text" value="11"/>	<b>Options</b> <input type="text" value="12"/>
<b>SD</b> Standard Diffuser	<b>NA</b> None <b>ACM</b> Acuity nLight Module Only <b>CCS</b> Casambi Module	<b>NA</b> None <b>EM120V</b> Emergency Pack <b>EM277V</b> Emergency Pack <b>EMCKT</b> Emergency Circuit <b>DAYCKT</b> Daylight Circuit	<b>NA</b> None <b>CAN-X<sup>1</sup></b> Canopy + Color <b>SJ-X<sup>2</sup></b> SJ Cord + Color <b>FC<sup>3</sup></b> Flat Canopy
	<small>Consult factory for other options.</small>	<small><sup>1</sup>White SJ cord and canopy provided, use above nomenclature for other requests. <sup>2</sup>See finish options here. <sup>3</sup>Remote drivers only</small>	

## Performance

Output <sup>1</sup>	Watts/ft	Lumens/ft
Low	28	2687
Medium	36	3354
High	45	4065

<sup>1</sup>Based on a typically configured 90 CRI, 3500K luminaire using one driver.

Custom outputs available. Please consult factory.  
For 4000K multiply by 1.05; for 3000K 0.96; for 2700K, 0.92

## Technical Information



click [here](#) or scan QR code

Wiring diagrams, PoE and sensor details

Modification date: October, 2021

Page 2 of 3

# Loop 3ft direct

## Drivers & Electrical

Our Power Over Wire system delivers power to the luminaire via suspension cables, eliminating a separate power feed. Drivers are housed in the luminaire canopy or in factory supplied remote enclosures<sup>1</sup>. All drivers are dimmable.

<sup>1</sup>See order information for more details.

## Emergency Back-Up

Emergency, battery-powered drivers are available. Emergency circuits for use with building generators are also available.

## PoE (Power over Ethernet)

Compatible with virtually all PoE systems including Molex Coresync, Igor, Smartengine, Platformatics, and NuLED SPICEbox. Consult Factory for systems not listed, See [here](#) for more info.

## Weight

10 lbs

## Mounting

## Optics

Custom opal lens provides excellent diffusion, high transmission, and no LED imaging.

## Construction

Die formed, heavy gauge rolled steel.

## Finishes

All luminaires are finished in high quality polyester powder coating. Our standard color is white. Any RAL color may be specified.

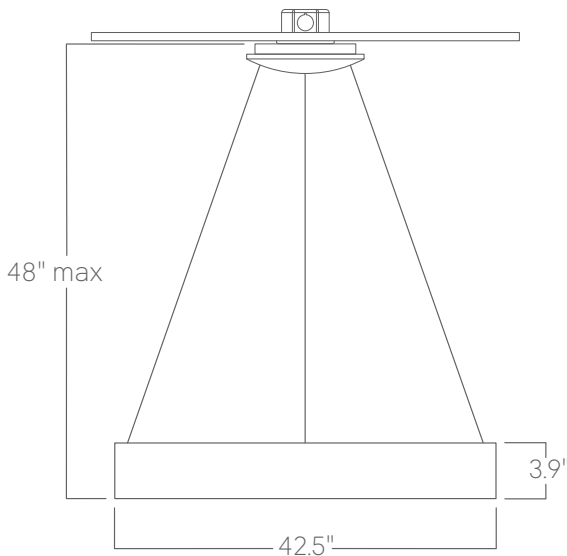

**Power over aircraft cable**

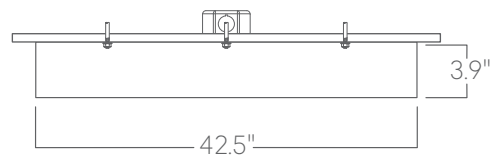

**Surface mount**