

Loop 3ft

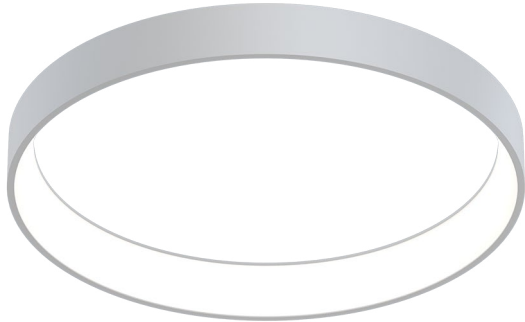

Our Performance Decorative luminaires offer a variety of decorative forms and sizes suitable for any modern space.

Features

- Power Over Wire system eliminates power cord
- Indirect and direct light distribution
- Cold-rolled steel housing
- Specifiable color temperature. CRI > 90, R9 >50
- Custom colors and wood finishes finishes available
- Specifiable dimmable drivers or PoE
- 5 Year, 50,000 hour warranty
- WELL Building Standard compatible [learn more](#)

Dimensions

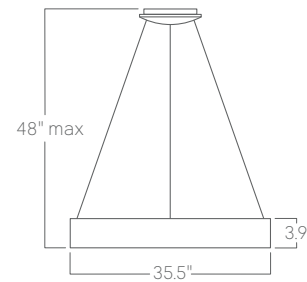

Optics

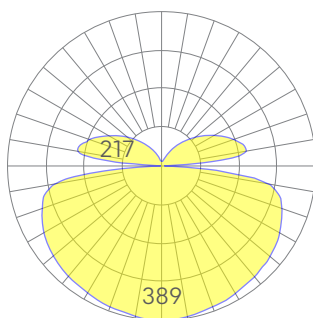

low

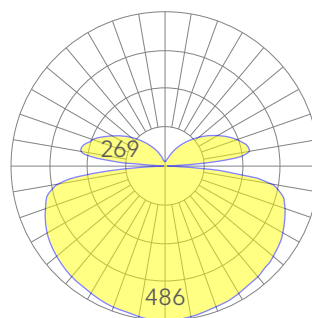

medium

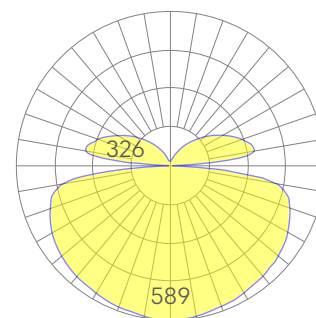

high

Representative distribution and peak candela. For other options see order information or IES files [here](#).

Loop 3ft

Ordering Information



Example: LOOP - 8 - 35 - MED - UNV - DB - W - AC - SD - CCS - DAYCKT - NA

Fixture ID <input type="text" value="1"/>	Length <input type="text" value="2"/>	Color Temperature <input type="text" value="3"/>	Output <input type="text" value="4"/>
LOOP	3 3 ft	27 2700K/90 CRI 30 3000K/90 CRI 35 3500K/90 CRI 40 4000K/90 CRI 50 5000K/90 CRI	LOW Low output MED Medium output HIGH High output CUST Custom output ¹
Voltage <input type="text" value="5"/>	Driver <input type="text" value="6"/>	Finish <input type="text" value="7"/>	Mounting <input type="text" value="8"/>
UNV Universal (120/277V) 347V¹ 347V	DB¹ Standard 0-10V 1% DB.1%² 0-10V 0.1% PoE³ Power over Ethernet	W White BLK Black CC¹ Custom Color CWF¹ Custom Wood Finish	ACP Power Over Aircraft Cable SM Surface Mount
<small>¹Must use DB Driver</small>	<small>¹Driver housed in canopy ²Driver housed in remote enclosure. ³Housing varies. Consult factory</small>	<small>¹Custom Color. See finish options here. White SJ cord and canopy provided, for other requests, see section 12 to specify.</small>	<small>White canopy provided. Must specify other requests.</small>
Optics <input type="text" value="9"/>	Sensors/Controls <input type="text" value="10"/>	Circuit <input type="text" value="11"/>	Options <input type="text" value="12"/>
SD Standard Diffuser	NA None ACM Acuity nLight Module Only CCS Casambi Module	NA None EM120V Emergency Pack EM277V Emergency Pack EMCKT Emergency Circuit DAYCKT Daylight Circuit	NA None CAN-X¹ Canopy + Color SJ-X² SJ Cord + Color FC³ Flat Canopy
	<small>Consult factory for other options.</small>		<small>¹White SJ cord and canopy provided, use above nomenclature for other requests. ²See finish options here. ³Remote drivers only</small>

Performance

Output ¹	Watts	Lumens
Low	28	2687
Medium	36	3354
High	45	4065

¹Based on a typically configured 90 CRI, 3500K luminaire using one driver.

Custom outputs available. Please consult factory.
For 4000K multiply by 1.05; for 3000K 0.96; for 2700K, 0.92

Technical Information



click [here](#) or scan QR code

Wiring diagrams, PoE and sensor details

Modification date: November, 2021

Page 2 of 3

Loop 3ft

Drivers & Electrical

Our Power Over Wire system delivers power to the luminaire via suspension cables, eliminating a separate power feed. Drivers are housed in the luminaire canopy or in factory supplied remote enclosures¹. All drivers are dimmable.

¹See order information for more details.

Emergency Back-Up

Emergency, battery-powered drivers are available. Emergency circuits for use with building generators are also available.

PoE (Power over Ethernet)

Compatible with virtually all PoE systems including Molex Coresync, Igor, Smartengine, Platformatics, and NuLED SPICEbox. Consult Factory for systems not listed, See [here](#) for more info.

Weight

10 lbs

Mounting

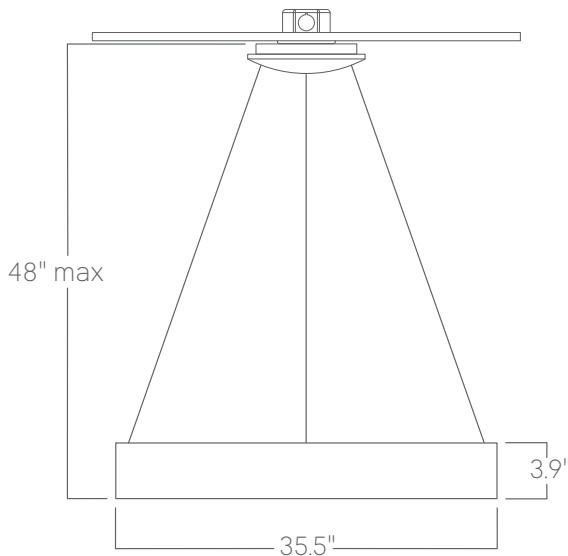

Power over aircraft cable

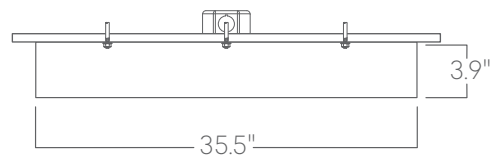

Surface mount

Optics

Custom opal lens provides excellent diffusion, high transmission, and no LED imaging.

Construction

Die formed, heavy gauge rolled steel.

Finishes

All luminaires are finished in high quality polyester powder coating. Our standard color is white. Any RAL color may be specified.