

Loop 18in direct

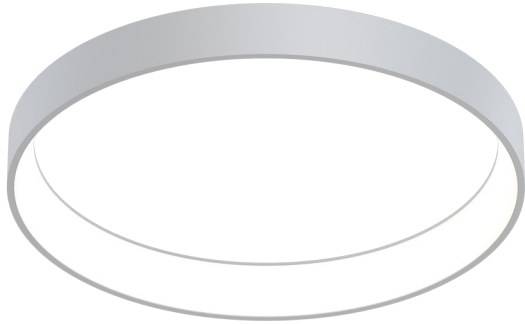

Our Performance Decorative luminaires offer a variety of decorative forms and sizes suitable for any modern space.

Features

- Power Over Wire system eliminates power cord
- Indirect and direct light distribution
- Cold-rolled steel housing
- Specifiable color temperature. CRI > 90, R9 >50
- Custom colors and wood finishes finishes available
- Specifiable dimmable drivers or PoE
- 5 Year, 50,000 hour warranty
- WELL Building Standard compatible [learn more](#)

Dimensions

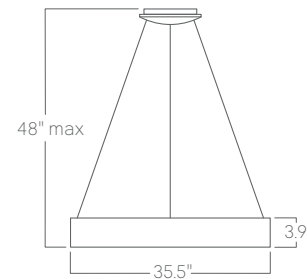

Optics

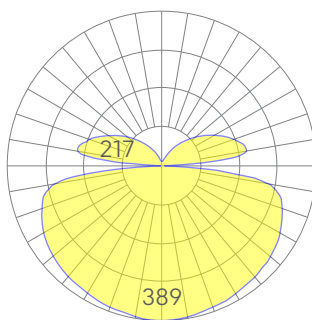

low

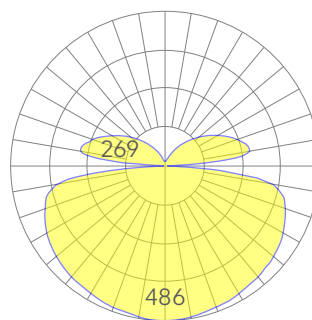

medium

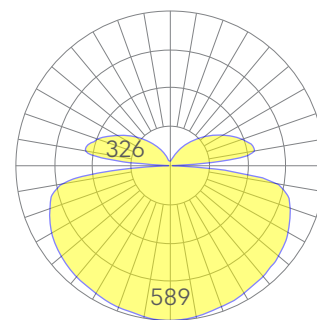

high

Representative distribution and peak candela. For other options see order information or IES files [here](#).

Loop 18in direct

Ordering Information



Example: Loop - 8 - 35 - MED - UNV - DB - W - AC - SD - CCS - DAYCKT - NA

Fixture ID	1	Length	2	Color Temperature	3	Output	4
Loop		18 18 in.		27 2700K/90 CRI 30 3000K/90 CRI 35 3500K/90 CRI 40 4000K/90 CRI 50 5000K/90 CRI		LOW Low output MED Medium output HIGH High output CUST Custom output ¹	
Voltage	5	Driver	6	Finish	7	Mounting	8
UNV 347V ¹ Universal (120/277V) 347V		DB ¹ Standard 0-10V 1% DB.1% ² 0-10V 0.1% PoE ³ Power over Ethernet		W White BLK Black CC ¹ Custom Color CWF ¹ Custom Wood Finish		ACP Power Over Aircraft Cable SM Surface Mount	
¹ Must use DB Driver		¹ Driver housed in canopy. ² Driver housed in remote enclosure. ³ Housing varies. Consult factory		¹ Custom Color. See finish options here. White SJ cord and canopy provided; for other requests, see section 12 to specify.		White canopy provided. Must specify other requests.	
Optics	9	Sensors/Controls	10	Circuit	11	Options	12
SD Standard Diffuser		NA None ACM Acuity nLight Module Only CCS Casambi Module		NA None EM120V Emergency Pack EM277V Emergency Pack EMCKT Emergency Circuit DAYCKT Daylight Circuit		NA None CAN-X ¹ Canopy + Color SJ-X ² SJ Cord + Color FC ³ Flat Canopy	
		Consult factory for other options.				¹ White SJ cord and canopy provided, use above nomenclature for other requests. ² See finish options here. ³ Remote drivers only	

Performance

Output ¹	Watts	Lumens
Low	21	1419
Medium	30	1971
High	40	2549

Based on a typically configured 90 CRI, 3500K luminaire using one driver.²

¹Custom outputs available. Please consult factory.

²For 4000k, multiply by 1.05; for 3000k, 0.9%; for 2700k, 0.92.

Technical Information



click [here](#) or scan QR code

Wiring diagrams, PoE and sensor details

Modification date: October, 2021

Page 2 of 3

Loop 18in direct

Drivers & Electrical

Our Power Over Wire system delivers power to the luminaire via suspension cables, eliminating a separate power feed. Drivers are housed in the luminaire canopy or in factory supplied remote enclosures¹. All drivers are dimmable.

¹See order information for more details.

Emergency Back-Up

Emergency, battery-powered drivers are available. Emergency circuits for use with building generators are also available.

PoE (Power over Ethernet)

Compatible with virtually all PoE systems including Molex Coresync, Igor, Smartengine, Platformatics, and NuLED SPICEbox. Consult Factory for systems not listed, See [here](#) for more info.

Weight

5 lbs

Mounting

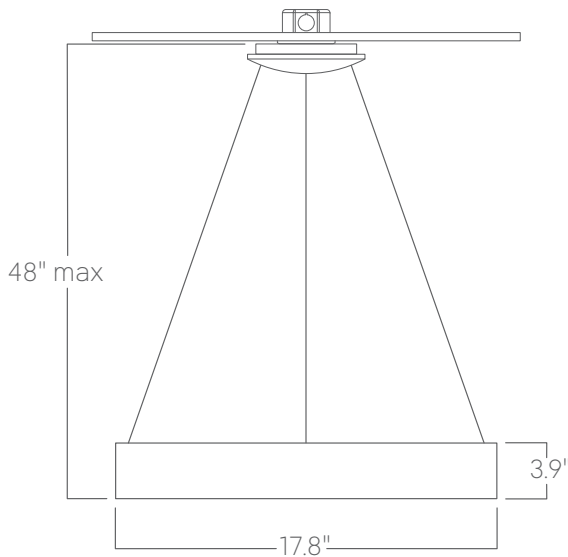

Power over aircraft cable

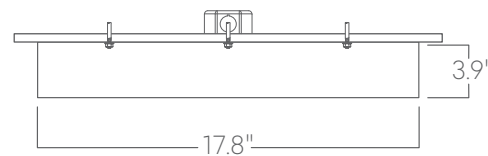

Surface mount

Optics

Custom opal lens provides excellent diffusion, high transmission, and no LED imaging.

Construction

Die formed, heavy gauge rolled steel.

Finishes

All luminaires are finished in high quality polyester powder coating. Our standard color is white. Any RAL color may be specified.