

# Ray4 recessed



The LS Series of architectural luminaires offers a wide range of profiles and mounting options. Custom lengths and patterns are tailored to suit any modern space.

## Features

- Extruded, recycled aluminum housing
- Aluminum core LED boards, specifiable output
- Specifiable color temperature. CRI > 90, R9 >50
- Custom lengths, welded patterns, and finishes available
- Integral specifiable dimmable drivers or PoE
- 5 Year, 50,000 hour warranty
- WELL Building Standard compatible [learn more](#)

## Dimensions

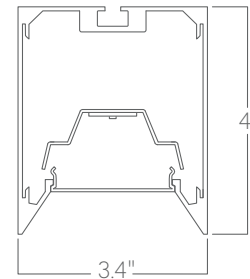

## Optics

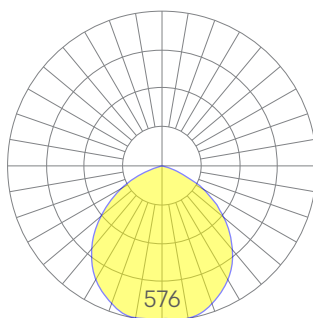

low

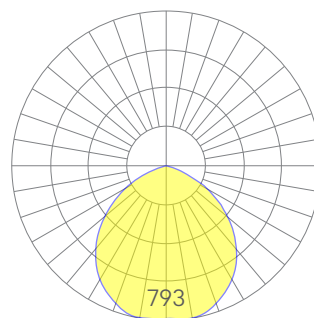

medium

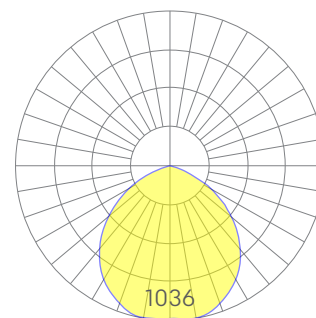

high

Representative distribution and peak candela. For other options see order information or IES files [here](#).

# Ray4 recessed

## Ordering Information



Example: RAY4 REC - 8 - 35 - MED - UNV - DB - W - AC - SD - CCS - DAYCKT - NA

Fixture ID	1	Length	2	Color Temperature	3	Output	4
RAY4 REC		<b>2</b> 2 ft <b>4</b> 4 ft <b>8</b> 8 ft <b>X'-X"</b> Specify Length <sup>1</sup> <b>PAT</b> Pattern (Consult Factory)		<b>27</b> 2700K/90 CRI <b>30</b> 3000K/90 CRI <b>35</b> 3500K/90 CRI <b>40</b> 4000K/90 CRI <b>50</b> 5000K/90 CRI  <b>WD</b> <sup>1</sup> Warm Dim 2200K-3000K <b>TW</b> <sup>2</sup> Tunable white 2700K-6500K <b>RGBW30</b> <sup>3</sup> RGB +white, 3000k <b>RGBW35</b> <sup>3</sup> RGB +white, 3500k <b>RGBW40</b> <sup>3</sup> RGB +white, 4000k		<b>LOW</b> Low output <b>MED</b> Medium output <b>HIGH</b> High output <b>CUST</b> Custom output <sup>1</sup>	
		<sup>1</sup> Precision lengths may be specified to the nearest 1/8".		<sup>1</sup> Must use WD10 driver <sup>2</sup> Must use TW10 or PS0driver <sup>3</sup> Must use remote DMX driver		<sup>1</sup> consult factory	
Voltage	5	Driver	6	Finish	7	Mounting	8
<b>UNV</b> Universal (120/277V) <b>347V</b> 347V		<b>DB</b> Standard 0-10V 1% <b>DB.1%</b> 0-10V 0.1% <b>ELV</b> 2-wire 1% (120V only) <b>TRI</b> Forward phase (120V only) <b>LDE1</b> Lutron Digital EcoSystem <b>DALI</b> DALI-2 Driver <b>PoE</b> Power over ethernet <b>TW10</b> Dual channel, 0-10V for tunable white.  <b>WD10</b> 0-10V Warm Dim <b>PSQ</b> Lutron T-Series 2-channel 1% for tunable white <b>DMX</b> <sup>1</sup> DMX512		<b>W</b> White <b>BLK</b> Black <b>CC</b> <sup>1</sup> Custom Color		<b>T</b> 9/16" Tee Grid <b>T15</b> 15/16" Tee Grid <b>SG</b> Slot Grid/Interlude <b>F</b> Flange <b>NT</b> Mud-in Flange <b>PM-X</b> Perimeter Mount <b>MW</b> <sup>2</sup> Millwork	
		<sup>1</sup> Set to default address 001.RDM capable. Contact us for other addressing needs. All DMX drivers provided in remote enclosures.		<sup>1</sup> Custom Color. See finish options here.		<sup>1</sup> 'X' denotes mounting type on opposite side of wall (eg PM-NT) <sup>2</sup> Consult Factory	
Optics	9	Sensors/Controls	10	Circuit	11	Options	12
<b>SD</b> Standard Diffuser		<b>NA</b> None <b>ACM</b> Acuity nLight Module Only <b>CCS</b> Casambi Module		<b>NA</b> None <b>EM120V</b> Emergency Pack <b>EM277V</b> Emergency Pack <b>EMCKT</b> Emergency Circuit <b>DAYCKT</b> Daylight Circuit		<b>NA</b> None <b>CAN-X</b> <sup>1</sup> Canopy + color <b>SJ-X</b> <sup>2</sup> SJ Cord + color	
		Consult factory for other options.				<sup>1</sup> White SJ cord and canopy provided, use above nomenclature for other requests. <sup>2</sup> See finish options here	

## Performance

Output <sup>1</sup>	Watts/ft	Lumens/ft
Low	5	401
Medium	7	551
High	10	720

<sup>1</sup>Based on a typically configured 90 CRI, 3500K luminaire using one driver.

Custom outputs available. Please consult factory.  
For 4000K multiply by 1.05; for 3000K 0.96; for 2700K, 0.92

## Technical Information



click [here](#) or scan QR code

Wiring diagrams, PoE and sensor details

Modification date: October,2021

Page 2 of 4

# Ray4 recessed

## Drivers & Electrical

Integral drivers\* with 0-10V Dimming standard. Several other driver options available; see ordering information.

\*DMX drivers are provided in remote enclosures.

## Sensors & Controls

Sensors are installed on an aluminum plate adjacent to the luminaire lens. Coronet remains agnostic in our approach to sensors and control systems; our fixtures are compatible with most systems offered.

\*Not applicable to indirect only models. Consult factory.

## Emergency Back-Up

For fixtures three-feet or longer, a 4W integral emergency driver may be wired to 4ft sections. 7W, 10W, and 12W drivers are also available (not all integral; consult factory). Emergency circuits for use with building generators are also available.

## PoE (Power over Ethernet)

Compatible with virtually all PoE systems including Moxex Coresync, Igor, Smartengine, Platformatics, and NuLED SPICEbox. Consult Factory for systems not listed, See [here](#) for more info.

## Finishes

All luminaires are finished in high quality polyester powder coating. Our standard color is white. Any RAL color may be specified.

## Weight

6lbs per foot

## Patterns

Featuring illuminated welded corners and angles. Consult factory for custom designs.

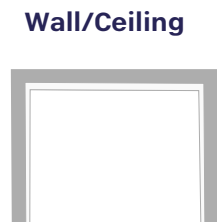
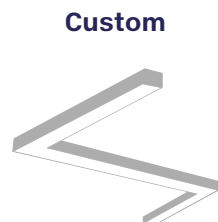
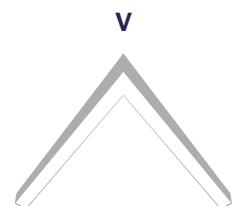
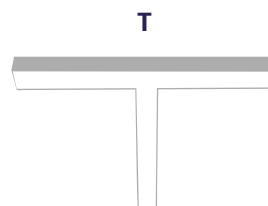
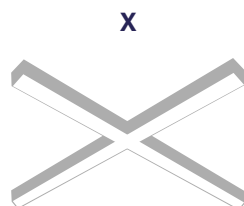
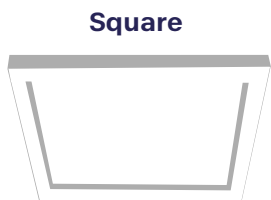

## Optics

Extruded satin acrylic lenses provide excellent diffusion, high transmission, and no LED imaging.

## Construction

Housings are extruded premium, recycled aluminum. Individual fixtures are available up to 12' long and may be specified as nominal or precision lengths. Precision lengths are supplied within 1/8" tolerance.

## Joined Runs

Runs of any length may be specified and are comprised of multiple, factory-engineered, joined sections. Individually specified luminaires are not field joinable.

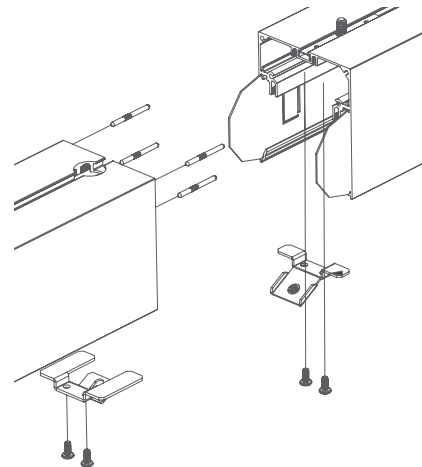

Representative joinery. For product specific details see installation guides or submittal drawings.

# Ray4 recessed

## Mounting Options

Custom mounting types and ceiling transitions available; consult factory.

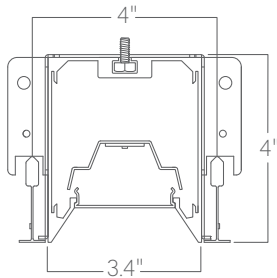

**T**  
9/16" tee grid

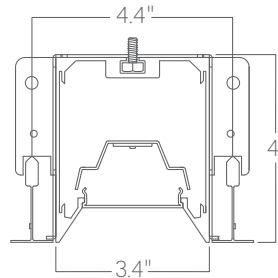

**T15**  
15/16" tee grid

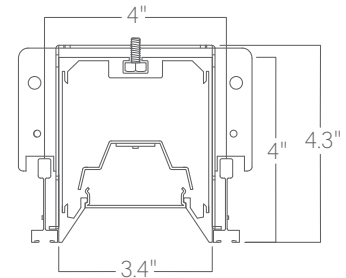

**SG**  
slot grid

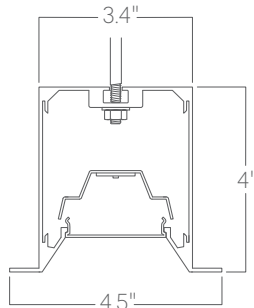

**F**  
flange

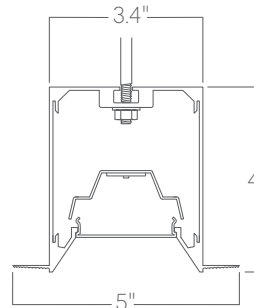

**NT**  
mud-in<sup>1</sup>

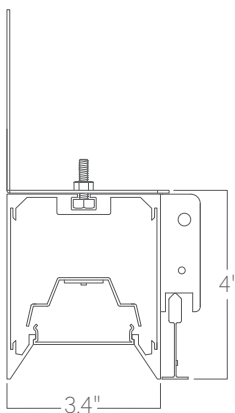

**PM-T**  
perimeter to 9/16" tee grid

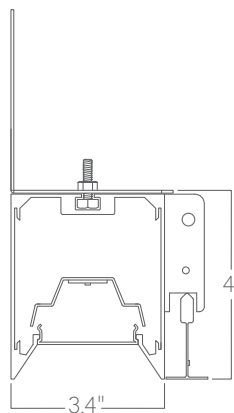

**PM-T15**  
perimeter to 15/16" tee grid

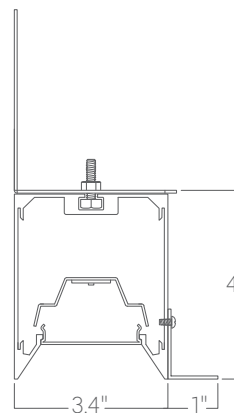

**PM-F**  
perimeter to flange

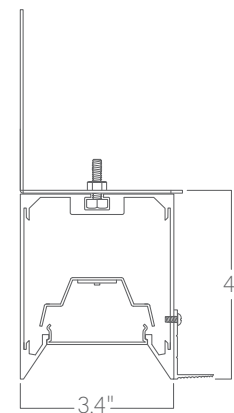

**PM-NT**  
perimeter to mud-in

<sup>1</sup>Installation that alters aperture width compromises lens security. Installer must ensure aperture width is maintained.