

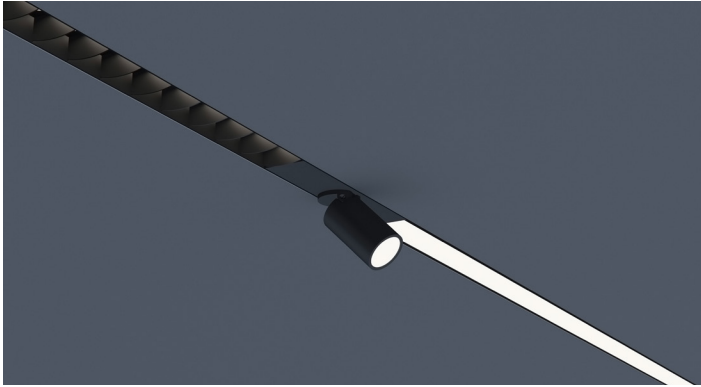

## MAGNETO Track System

MAGNETO is an innovative and dynamic track system designed for ease and flexibility. Featuring snap-in magnetic mounting that allows you to rearrange three different modules. Fully customizable to suit your specific needs.

DATE	PROJECT	FIRM	TYPE
------	---------	------	------



Recessed, linear low voltage configurable track system with the flexibility of magnetically mounted modules for ease of on-site adjustability and install. Configure in patterns or runs to meet design requirements.

### FEATURES

- Two Circuits to Power Magneto Modules
- Available In Made To Measure Lengths Accurate Up To 1/16"
- Patterns Available (See Page 2)
- All Circuits Are Dimmable To 1% With 0-10V Controls. Uplight Is At 10%
- CRI 90+ Standard; R9>50

<b>APPLICATIONS</b>	Commercial Interiors, Galleries, Retail, Museums, Reception Areas, Hotels, Restaurants		
---------------------	--	--	--

<b>CONSTRUCTION</b>	Extruded Housing with Steel End Plates	<b>OPTICS</b>	N/A
---------------------	--	---------------	-----

<b>WARRANTY</b>	5 Year Limited Warranty (Covers Standard Components)	<b>FINISH</b>	Powder-Coated Black Standard. Optional White Powder-Coated Finish. Custom RAL Colors Available
-----------------	--	---------------	--

<b>FIXTURE RATINGS &amp; CERTIFICATIONS</b>	Union Made	Made In The USA	
	ETL Listed	Damp Location Rated	

**DRIVERS & SENSORS**

For Wiring Diagrams and Sensor Information Click [Here](#)



<b>ELECTRICAL</b>	Uplight and dual circuit track. Remote constant voltage driver with integral 1% 0-10V dimming for track. Do not exceed 80% of driver max per circuit. 32ft maximum remote driver distance from feed. Track must be re-fed every 30ft or when driver max is reached (whichever comes first).
-------------------	---

### EXTRUSION DIMENSIONS

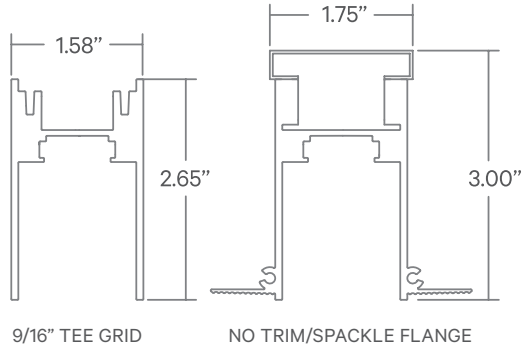

<b>ORDERING</b>	1	2	3	4	5	6	7
-----------------	---	---	---	---	---	---	---

<b>1 - FIXTURE ID</b> MAGR - TRK	<b>2 - LENGTH</b> 2 - 2 ft 4 - 4 ft 8 - 8 ft X'-X'' - Specify Length PAT - Pattern (Consult Factory)	<b>3 - DRIVER CKT1 (Track)</b> DR30* - 30W Driver DR60* - 60W Driver DR96* - 96W Driver  *Note: Drivers can be remotod up to 32'. 30' of track maximum per driver	<b>4 - DRIVER CK2 (Track)</b> DR30 - 30W Driver DR60 - 60W Driver DR96 - 96W Driver	<b>5 - VOLTAGE</b> UNV - Universal (120/277V)
<b>6 - MOUNTING</b> T - 9/16" Tee Grid T15 - 15/16" Tee Grid SG - Slot Grid NT - No Trim/Spackle Flange	<b>7 - FINISH</b> BLK* - Black (Standard) CC - Custom Color (provide RAL#)  *Interior finish comes standard black, custom colors available. Consult factory			

DATE

PROJECT

FIRM

TYPE

### PATTERNS

Patterns feature illuminated corners and angles. **Must consult factory for custom corners and patterns.**

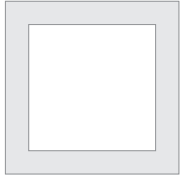

Square Patterns



X Patterns

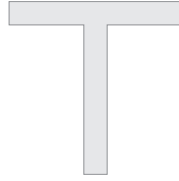

T Patterns

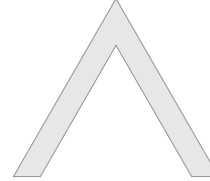

Custom Angles

DATE	PROJECT	FIRM	TYPE
------	---------	------	------

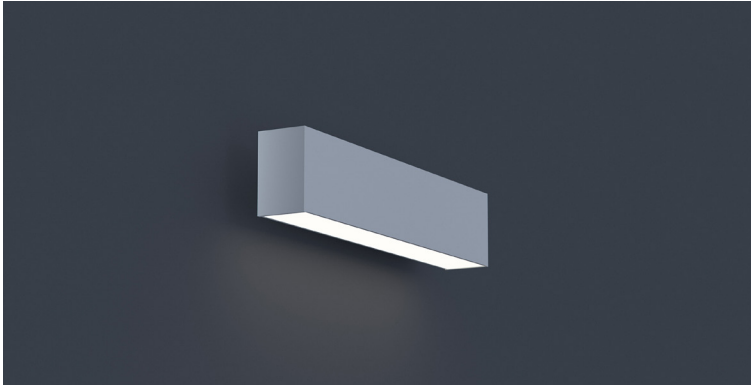

Magneto linear module. Connects to Magneto low voltage track to provide linear downlighting.

### FEATURES

- Magnetically Held Fixture Designed to Be Easily Repositioned in Magneto Track On Site
- Available in Lengths Up To 8' (6" Increments)
- 5 Year, 50,000 Hour Fixture Warranty
- 2700K, 3000K, 3500K & 4000K Color Temperatures Available
- 0-10V Dimmable
- CRI 90+ Standard; R9>50

**APPLICATIONS** Commercial Interiors, Galleries, Retail, Museums, Reception Areas, Hotels, Restaurants

**CONSTRUCTION** Extruded and Cast Aluminum Components | **OPTICS** Extruded High Transmission Satin Acrylic Lens with No LED Imaging

**WARRANTY** 5 Year Limited Warranty (Covers Standard Components) | **FINISH** Powder-Coated Black Standard. Optional White Powder-Coated Finish. Custom RAL Colors Available

**FIXTURE RATINGS & CERTIFICATIONS** Union Made ETL Listed | Made In The USA Damp Location Rated



### DRIVERS & SENSORS

For Wiring Diagrams and Sensor Information Click [Here](#)



**ELECTRICAL** Powered by Magneto Track System. 0-10V Dimmable. Do Not Exceed 90W Per Circuit. 'Flip' Fixture in Track to Select Circuit

### EXTRUSION DIMENSIONS

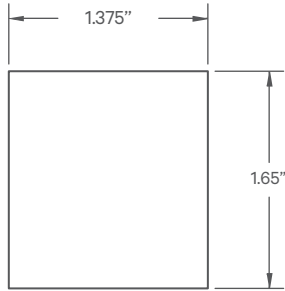

### LED SYSTEM INFORMATION

	Nominal System Watts	Nominal Delivered Lumens
Standard (LTG1)	8 W/ft	500 lm/ft
Low (LTG2)	4.5 W/ft	280 lm/ft

NOTE: Based on a 3500K luminaire



1 - FIXTURE ID	2 - LENGTH	3 - COLOR TEMP	4 - LED SYSTEM	5 - VOLTAGE	6 - FINISH
MAG - LIN	1' - 1 ft 2' - 2 ft 3' - 3 ft 4' - 4 ft 6' - 8 ft 8' - 8 ft X'-X" - Specify Length (To the nearest 6")	27 - 2700K/90 CRI 30 - 3000K/90 CRI 35 - 3500K/90 CRI 40 - 4000K/90 CRI	LTG1 - Standard LTG2 - Low	UNV - Universal (120/277V)	BLK - Black (Standard) CC - Custom Color (provide RAL#)

DATE \_\_\_\_\_ PROJECT \_\_\_\_\_ FIRM \_\_\_\_\_ TYPE \_\_\_\_\_

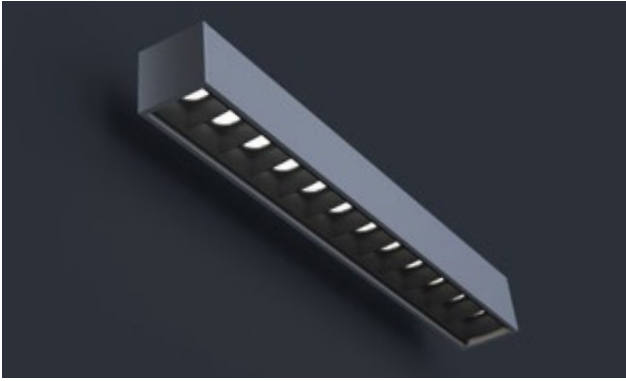

Magneto linear baffle module. Connects to Magneto low voltage track to provide linear downlighting.

**FEATURES**

- Magnetically Held Fixture Designed to Be Easily Repositioned in Magneto Track On Site
- Specifiable Optic Packages
- Available In Custom Lengths Up To 8' (1 Foot Increments)
- 5 Year, 50,000 Hour Fixture Warranty
- 2700K, 3000K, 3500K & 4000K Color Temperatures Available
- CRI 90+ Standard; R9>50

<b>APPLICATIONS</b>	Commercial Interiors, Galleries, Retail, Museums, Reception Areas, Hotels, Restaurants		
<b>CONSTRUCTION</b>	Extruded and Cast Aluminum Components. Injection Molded Poly-Carbonate Baffle	<b>OPTICS</b>	Optic Per LED; Various Beam Spreads Available. See Below
<b>WARRANTY</b>	5 Year Limited Warranty (Covers Standard Components)	<b>FINISH</b>	Powder-Coated Black Standard. Optional White Powder-Coated Finish. Custom RAL Colors Available
<b>FIXTURE RATINGS &amp; CERTIFICATIONS</b>	Union Made ETL Listed	Made In The USA Damp Location Rated	 <b>DRIVERS &amp; SENSORS</b> For Wiring Diagrams and Sensor Information Click <a href="#">Here</a>
<b>ELECTRICAL</b>	Powered by Magneto Track System. 0-10V Dimmable. Do Not Exceed 90W Per Circuit. 'Flip' Fixture in Track to Select Circuit		



**EXTRUSION DIMENSIONS**

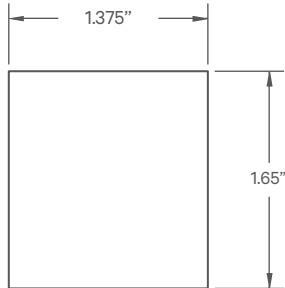

**LED SYSTEM INFORMATION**

	System Watts	Delivered Lumens	Efficacy
Standard (LTG1)	3 W/ft	303 lm/ft	110 LPW

\*Based on 'WFL' option

**BEAM SPREAD INFORMATION**

	SP	FL	WFL
CBCP	5816	4122	3116

**ORDERING**



<b>1 - FIXTURE ID</b> MAG - BAF	<b>2 - LENGTH</b> 1' - 1 ft 2' - 2 ft 3' - 3 ft 4' - 4 ft 6' - 8 ft 8' - 8 ft X'-X" - Specify Length (To the nearest 6")	<b>3 - COLOR TEMP</b> 27 - 2700K/90 CRI 30 - 3000K/90 CRI 35 - 3500K/90 CRI 40 - 4000K/90 CRI	<b>4 - LED SYSTEM</b> LTG1 - Standard	<b>5 - VOLTAGE</b> UNV - Universal (120/277V)	<b>6 - FINISH</b> BLK - Black (Standard) CC - Custom Color (provide RAL#)
<b>7 - FINISH (Baffle)</b> BLK - Black	<b>8 - BEAM SPREAD</b> SP - 20° Beam; (Spot) FL - 26° Beam Spread; (Flood) WFL - 32° Beam Spread; (Wide Flood)				

DATE \_\_\_\_\_ PROJECT \_\_\_\_\_ FIRM \_\_\_\_\_ TYPE \_\_\_\_\_



Small, magneto accent module. Connects to Magneto low voltage track to provide accent lighting.

### FEATURES

- Magnetically Held Fixture Designed to Be Easily Repositioned in Magneto Track On Site
- Three Beam Spreads Available
- CRI 90+ Standard; R9>50
- Glare Control Accessory Available
- Module is Dimmable Using a 0-10V Control Wired to the Magneto Track
- 2700K, 3000K, 3500K & 4000K Color Temperatures Available

<b>APPLICATIONS</b>	Commercial Interiors, Galleries, Retail, Museums, Reception Areas, Hotels, Restaurants		
<b>CONSTRUCTION</b>	Extruded and Cast Aluminum Components	<b>OPTICS</b>	Field Changeable Optic; Beam Angle of 24°, 27°, and 30° Available. Optional Hex Louver Available
<b>WARRANTY</b>	5 Year Limited Warranty (Covers Standard Components)	<b>FINISH</b>	Powder-Coated Black Standard. Optional White Powder-Coated Finish. Custom RAL Colors Available
<b>FIXTURE RATINGS &amp; CERTIFICATIONS</b>	Union Made ETL Listed	Made In The USA Damp Location Rated	 <b>DRIVERS</b> For Wiring Diagrams <a href="#">Click Here</a>
<b>ELECTRICAL</b>	Powered by Magneto Track System. 0-10V Dimmable. 'Flip' Fixture in Track to Select Circuit		



### EXTRUSION DIMENSIONS

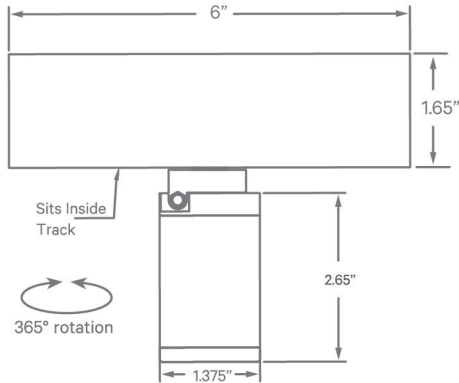

### LED SYSTEM INFORMATION

	Nominal System Watts	Nominal Delivered Lumens
SM	5 W	328 lm

\*Based on 'WFL' option in 3500K

**ORDERING** 1 2 3 4 5 6 7 8

<b>1 - FIXTURE ID</b> MAG - SPT	<b>2 - SIZE</b> SM	<b>3 - COLOR TEMP</b> 27 - 2700K/90 CRI 30 - 3000K/90 CRI 35 - 3500K/90 CRI 40 - 4000K/90 CRI	<b>4 - LED SYSTEM</b> LTG1 - Standard	<b>5 - VOLTAGE</b> UNV - Universal (120/277V)	<b>6 - FINISH</b> BLK - Black (Standard) CC - Custom Color (provide RAL#)
------------------------------------	-----------------------	---	--	--	---

<b>7 - BEAM SPREAD</b> SP - 24° Beam; 1754 CBCP FL - 27° Beam Spread; 1700 CBCP WFL - 30° Beam Spread; 994 CBCP
--

<b>8 - OPTIONAL ACCESSORIES</b> HEX - Hex Louver
---

DATE	PROJECT	FIRM	TYPE
------	---------	------	------

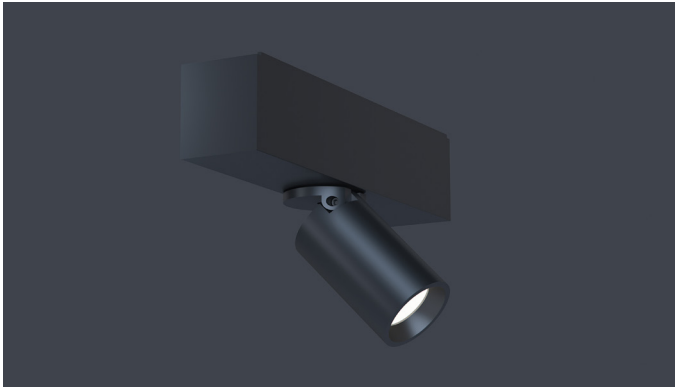

Magneto accent module. Connects to Magneto low voltage track to provide accent lighting.

### FEATURES

- Magnetically Held Fixture Designed to Be Easily Repositioned in Magneto Track On Site
- Three Beam Spreads Available
- CRI 90+ Standard; R9>50
- Glare Control Accessory Available
- Module is Dimmable Using a 0-10V Control Wired to the Magneto Track
- 2700K, 3000K, 3500K & 4000K Color Temperatures Available

**APPLICATIONS** Commercial Interiors, Galleries, Retail, Museums, Reception Areas, Hotels, Restaurants

**CONSTRUCTION** Extruded and Cast Aluminum Components | **OPTICS** Field Changeable Optic; Beam Angle of 15°, 38°, and 60° Available.

**WARRANTY** 5 Year Limited Warranty (Covers Standard Components) | **FINISH** Powder-Coated Black Standard. Optional White Powder-Coated Finish. Custom RAL Colors Available

**FIXTURE RATINGS & CERTIFICATIONS** Union Made ETL Listed | Made In The USA Damp Location Rated



**DRIVERS**  
For Wiring Diagrams Click [Here](#)



**ELECTRICAL** Powered by Magneto Track System. 0-10V Dimmable. 'Flip' Fixture in Track to Select Circuit

### EXTRUSION DIMENSIONS

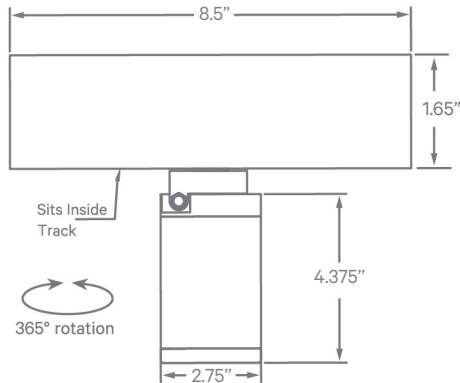

### LED SYSTEM INFORMATION

	Nominal System Watts	Nominal Delivered Lumens
MED	8 W	615 lm

\*Based on 'WFL' option in 3500K

### ORDERING

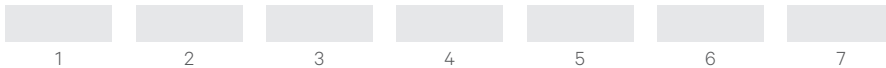

<b>1 - FIXTURE ID</b> MAG - SPT	<b>2 - SIZE</b> MED	<b>3 - COLOR TEMP</b> 30 - 3000K/90 CRI 35 - 3500K/90 CRI	<b>4 - LED SYSTEM</b> LTG1 - Standard	<b>5 - VOLTAGE</b> UNV - Universal (120/277V)	<b>6 - FINISH</b> BLK - Black (Standard) CC* - Custom Color (provide RAL#) <small>*Additional lead time</small>
------------------------------------	------------------------	---	--	--	--

### 7 - BEAM SPREAD

- SP - 15° Beam
- FL - 38° Beam Spread
- WFL - 60° Beam Spread



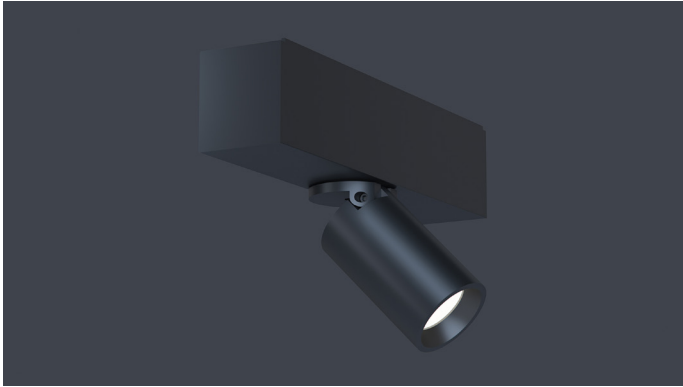

DATE	PROJECT	FIRM	TYPE
------	---------	------	------



Magneto accent module. Connects to Magneto low voltage track to provide accent lighting.

### FEATURES

- Magnetically Held Fixture Designed to Be Easily Repositioned in Magneto Track On Site
- Three Beam Spreads Available
- CRI 90+ Standard; R9>50
- Glare Control Accessory Available
- Module is Dimmable Using a 0-10V Control Wired to the Magneto Track
- 2700K, 3000K, 3500K & 4000K Color Temperatures Available

<b>APPLICATIONS</b>	Commercial Interiors, Galleries, Retail, Museums, Reception Areas, Hotels, Restaurants		
<b>CONSTRUCTION</b>	Extruded and Cast Aluminum Components	<b>OPTICS</b>	Field Changeable Optic; Beam Angle of 15°, 38°, and 60° Available.
<b>WARRANTY</b>	5 Year Limited Warranty (Covers Standard Components)	<b>FINISH</b>	Powder-Coated Black Standard. Optional White Powder-Coated Finish. Custom RAL Colors Available
<b>FIXTURE RATINGS &amp; CERTIFICATIONS</b>	Union Made ETL Listed	Made In The USA Damp Location Rated	 <b>DRIVERS</b> For Wiring Diagrams <a href="#">Click Here</a> 
<b>ELECTRICAL</b>	Powered by Magneto Track System. 0-10V Dimmable. 'Flip' Fixture in Track to Select Circuit		

### EXTRUSION DIMENSIONS

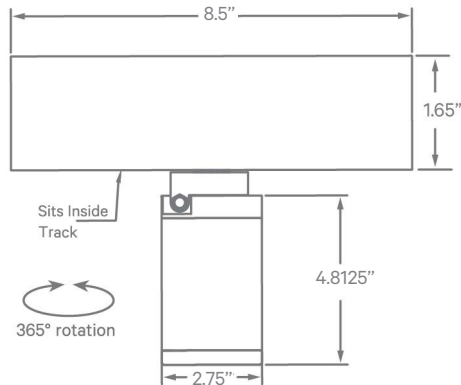

### LED SYSTEM INFORMATION

	Nominal System Watts	Nominal Delivered Lumens
LRG	15 W	1460 lm

### ORDERING



<b>1 - FIXTURE ID</b> MAG - SPT	<b>2 - SIZE</b> LRG	<b>3 - COLOR TEMP</b> 30 - 3000K/90 CRI 35 - 3500K/90 CRI	<b>4 - LED SYSTEM</b> LTG1 - Standard	<b>5 - VOLTAGE</b> UNV - Universal (120/277V)	<b>6 - FINISH</b> BLK - Black (Standard) CC* - Custom Color (provide RAL#) <small>*Additional lead time</small>
------------------------------------	------------------------	---	--	--	--

### 7 - BEAM SPREAD

- SP - 15° Beam
- FL - 24° Beam Spread
- WFL - 60° Beam Spread