

DATE	PROJECT	FIRM	TYPE
------	---------	------	------

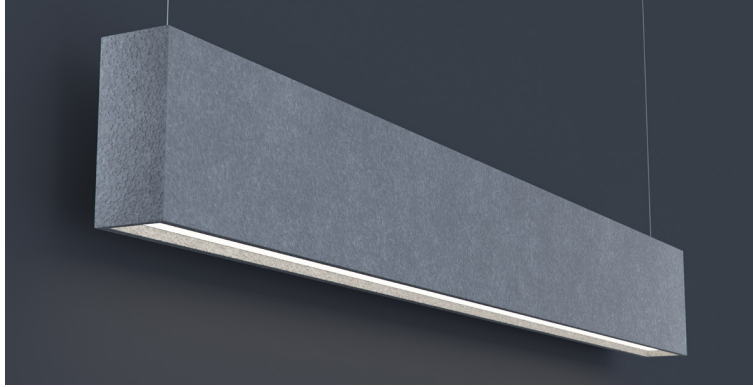

Coronet and Turf seamlessly bring together lighting and acoustical sound control into one configurable system. Perfect for open ceiling or tall spaces to control sound and provide lighting in one fixture.

FEATURES

- Direct/Indirect Lighting
- NRC (Noise Reduction Coefficient): of .75
- Acoustical felt is 99% recyclable and available in 17 colors standard.
- Available In Custom Lengths & Long Runs To 1/16" Accuracy
- CRI 90+ Standard
- 5 Year, 50,000 Hour Fixture Warranty
- 2700K, 3000K, 3500K, 4000K & 5000K Color Temperatures Available

APPLICATIONS Offices, Lobbies, Retail Stores, Classrooms, Reception Areas & Corridors

CONSTRUCTION Light Fixture: Aluminum Housing and Die Cast End Caps. Steel Gear Tray. **Baffle:** 99% Recycled Polyester Felt. **OPTICS** Extruded High Transmission Satin Acrylic Lens With No LED Imaging. Additional Optics Available.

WARRANTY 5 Year Limited Warranty (Covers Standard Components) **FINISH** FIXTURE: Standard Powder-Coated White. Custom RAL Colors Available. **BAFFLE:** See Page 3.

FIXTURE RATINGS & CERTIFICATIONS Union Made Made In The USA ETL Listed Damp Location Rated



ELECTRICAL Integral Driver With 0-10V 10% Dimming Standard. Several Driver Options Available. See Below For Lutron Dimming Information

2-Wire Forward Phase; Hi-Lume 1% Dimming, Only Available For 120V	LTEA
3-Wire EcoSystem; Hi-lume 1% Dimming	L3DA
Digital EcoSystem; Hi-lume 1% Dimming, 'Soft-on Fade-to-black' (Required for Daylighting)	LDE1
5 Series EcoSystem; 5% Dimming	LDE5

EXTRUSION DIMENSIONS

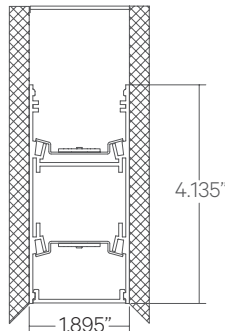

LED SYSTEM INFORMATION

	Nominal System Watts		Nominal Delivered Lumens	
	DIRECT	INDIRECT	DIRECT	INDIRECT
Standard (LTG1)	7.5 W/ft	7.5 W/ft	705 Lm/ft	250 Lm/ft
Low (LTG2)	5.25 W/ft	5.25 W/ft	485 Lm/ft	200 Lm/ft
High (LTG3)	9 W/ft	9 W/ft	810 Lm/ft	300 Lm/ft

Based on a 3500K luminaire using one driver. Please consult factory for custom lumen outputs & wattage.

1	2	3	4-IN	4-D	5	6	7	8	9	10-IN	10-D	11
---	---	---	------	-----	---	---	---	---	---	-------	------	----

1 - FIXTURE ID LS1 UP/DN - STFU	2 - LENGTH 2 - 2 ft 4 - 4 ft 8 - 8 ft x'-x" - Custom (specify length)	3 - COLOR TEMP 27 - 2700K/90 CRI 30 - 3000K/90 CRI 35 - 3500K/90 CRI 40 - 4000K/90 CRI 50 - 5000K/90 CRI TW* - Tunable White RGBW* - RGB + 3000K *Must use DMX Driver (Remote)	4 - LED SYSTEM IN - INDIRECT LTG1 - Standard LTG2 - Low LTG3 - High C - Custom Output (ie-C550Lm/ft)	5 - VOLTAGE UNV - Universal (120/277V)	6 - DRIVER DB - Standard 10% Dimming (0-10V) DB1% - 1% Dimming (0-10V) DB.01% - .01% Dimming (0-10V) LTEA* - Lutron 2-wire 1% Dimming L3DA* - Lutron 3-wire 1% Dimming LDE1* - Lutron Digital EcoSystem LDE5* - 5 Series EcoSystem; 5% Dimming *Refer to 'Electrical' Information Above DMX - For Color Tuning and RGBW
7 - FINISH (Fixture) W - White (Standard) BLK - Black CC - Custom Color (provide RAL#)	7 - FINISH (Baffle) 01 - Cream 04 - Light Gray 06 - Charcoal 07 - Black 48 - Light Brown	8 - MOUNTING ACC - Air Craft Cable To Canopy ACU - Air Craft Cable To Unistrut Channel	10 - OPTICS IN - INDIRECT SD - Standard Diffuser	D - DIRECT SD - Standard Diffuser ASYM - Asymmetric Optic BW - Batwing Optic	11 - OPTIONS SC - Separate Circuit EM 120V - Emergency Pack EM 277V - Emergency Pack

MOUNTING OPTIONS

ACC - Air Craft Cable Mounting (50") to Canopy

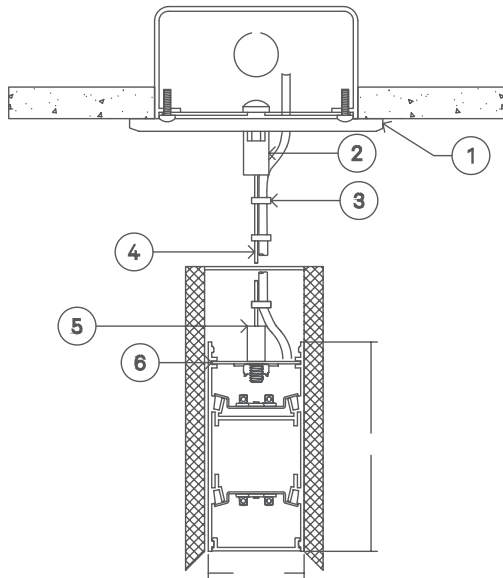

- 1 - 5" Round Canopy (Standard White Finish)
- 2 - Canopy Retainer
- 3 - SJT Cord (Standard White)
- 4 - Air Craft Cable
- 5 - Gripper
- 6 - Hanging Bracket

ACU - Air Craft Cable Mounting (50") to Unistrut Channel

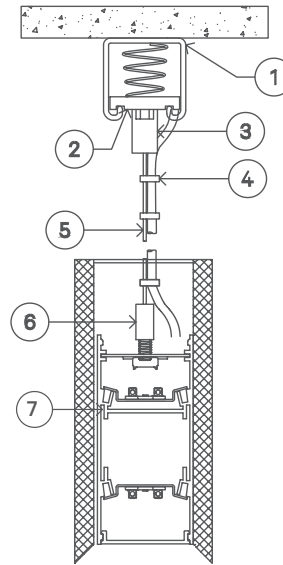

- 1 - Unistrut Channel
- 2 - Stud Nut
- 3 - Cable Retainer
- 4 - SJT Cord (Standard White)
- 5 - Air Craft Cable
- 6 - Gripper
- 7 - Hanging Bracket

DATE

PROJECT

FIRM

TYPE

BAFFLE/FELT COLORS:

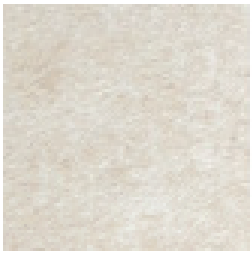

01 - CREAM

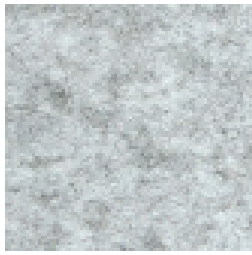

04 - LIGHT GRAY



05 - WHITE

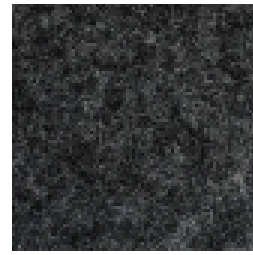

06 - CHARCOAL



07 - BLACK



48 - LIGHT BROWN



42 - ORANGE

NOTE: Other colors available; consult factory.