

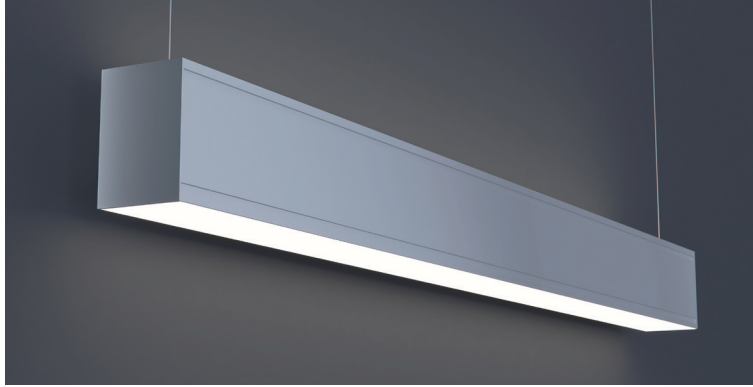



DATE	PROJECT	FIRM	TYPE
------	---------	------	------



Direct and indirect, architectural luminaire. For use in indoor applications where an LED luminaire providing continuous light is required. Suitable for suspended and wall mount installation.

FEATURES

- Available In Custom Lengths & Long Runs To 1/16" Accuracy
- Corners & Patterns Available (See Page 2)
- Damp Location Rated
- CRI 90+ Standard
- 5 Year, 50,000 Hour Fixture Warranty
- 2700K, 3000K, 3500K, 4000K & 5000K Color Temperatures Available
- Enlighted/Wattstopper Sensors Available

APPLICATIONS	Offices, Lobbies, Retail Stores, Classrooms, Reception Areas & Corridors			
CONSTRUCTION	Extruded Aluminum Housing And Cast End Caps. Formed Steel Gear Tray	OPTICS	Extruded High Transmission Satin Acrylic Lens With No LED Imaging. Additional Optics Available	
WARRANTY	5 Year Limited Warranty (Covers Standard Components)		FINISH	Standard Powder-Coated White. Custom RAL Colors Available
FIXTURE RATINGS & CERTIFICATIONS	Union Made ETL Listed	Made In The USA Damp Location Rated	  	

ELECTRICAL	Integral Driver With 0-10V 10% Dimming Standard. Several Driver Options Available. See Below For Lutron Dimming Information				
	2-Wire Forward Phase; Hi-Lume 1% Dimming, Only Available For 120V				LTEA
	3-Wire EcoSystem; Hi-lume 1% Dimming				L3DA
	Digital EcoSystem; Hi-lume 1% Dimming, 'Soft-on Fade-to-black' (Required for Daylighting)				LDE1
	5 Series EcoSystem; 5% Dimming				LDE5

EXTRUSION DIMENSIONS

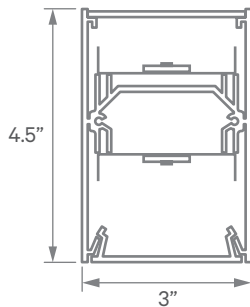

LED SYSTEM INFORMATION

	Nominal System Watts		Nominal Delivered Lumens		Nominal Efficacy
	DIRECT	INDIRECT	DIRECT	INDIRECT	
Standard (LTG1)	7.25 W/ft	7.25 W/ft	610 Lm/ft	660 Lm/ft	87 Lm/W
Low (LTG2)	5 W/ft	5 W/ft	420 Lm/ft	455 Lm/ft	88 Lm/W
High (LTG3)	8.75 W/ft	8.75 W/ft	700 Lm/ft	760 Lm/ft	81 Lm/W

Based on a 3500K luminaire using one driver. Please consult factory for custom lumen outputs & wattage.

ORDERING	1	2	3	4-IN	4-D	5	6	7	8	9	10-IN	10-D	11
-----------------	---	---	---	------	-----	---	---	---	---	---	-------	------	----

1 - FIXTURE ID LS3 LED UP/DN	2 - LENGTH 2 - 2 ft 4 - 4 ft 8 - 8 ft x'-x" - Custom (specify length) **Patterns available, consult factory	3 - COLOR TEMP 27 - 2700K/90 CRI 30 - 3000K/90 CRI 35 - 3500K/90 CRI 40 - 4000K/90 CRI 50 - 5000K/90 CRI TW* - Tunable White RGBW* - RGB + 3000K *Must use DMX Driver (Remote)	4 - LED SYSTEM IN - INDIRECT LTG1 - Standard LTG2 - Low LTG3 - High C - Custom Output (ie-C550Lm/ft)	D - DIRECT LTG1 - Standard LTG2 - Low LTG3 - High C - Custom Output (ie-C550Lm/ft)	5 - VOLTAGE UNV - Universal (120/277V)	6 - DRIVER DB - Standard 10% Dimming (0-10V) DB1% - 1% Dimming (0-10V) DB.01% - .01% Dimming (0-10V) LTEA* - Lutron 2-wire 1% Dimming L3DA* - Lutron 3-wire 1% Dimming LDE1* - Lutron Digital EcoSystem LDE5* - 5 Series EcoSystem; 5% Dimming *Refer to 'Electrical' Information Above DMX - For Color Tuning and RGBW
7 - FINISH W - White (Standard) BLK - Black CC - Custom Color (provide RAL#)	8 - MOUNTING AC - Air Craft Cable (50") WM - Wall Mount	9 - CONTROL EIS - Integral Sensor by Enlighted WIS - Integral Sensor by Wattstopper	10 - OPTICS IN - INDIRECT SD - Standard Diffuser BW - Batwing Optic ASYM - Asymmetric Optic	D - DIRECT SD - Standard Diffuser WW - Wall Wash Reflector ASYM - Asymmetric Optic	11 - OPTIONS EM 120V - Emergency Pack EM 277V - Emergency Pack	

DATE	PROJECT	FIRM	TYPE
------	---------	------	------

MOUNTING OPTIONS

AC - Air Craft Cable (50")

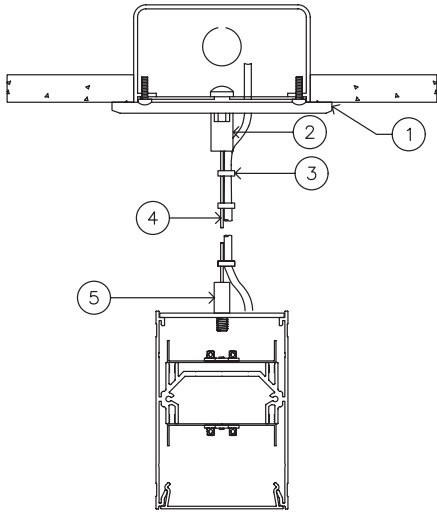

- 1 - 5" Round Canopy (Standard White Finish)
- 2 - Canopy Retainer
- 3 - SJT Cord (Standard White)
- 4 - Air Craft Cable
- 5 - Gripper
- 6 - Hanging Bracket

WM - Wall Mount

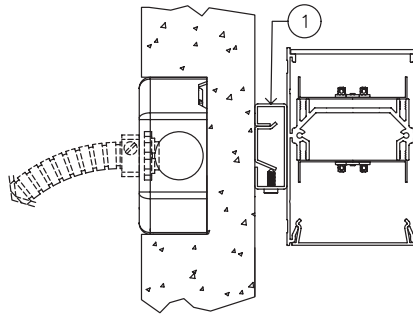

- 1 - 0.75" Wall Mount Bracket

CORNERS & PATTERNS

Available with illuminated corners, angles, and custom patterns. **Must consult factory for custom corners and patterns.**

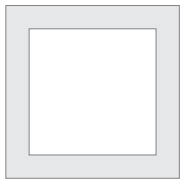

Square Patterns

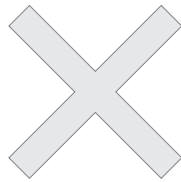

X Patterns

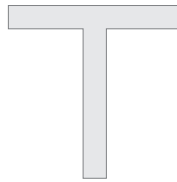

T Patterns

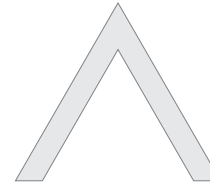

Custom Angles

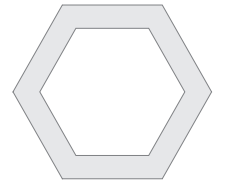

Custom Patterns

LENS CUT OPTIONS



Straight-cut

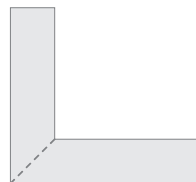

Mitered Angle

NOTE: Straight-Cut is standard configuration, Mitered Angle is optional and must be specified.

PHOTOMETRICS

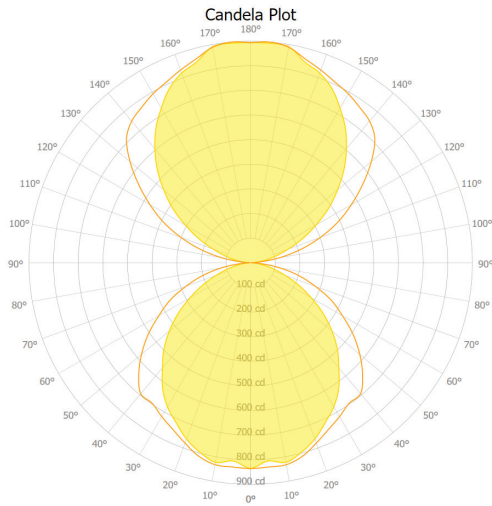

LS3 LED UPDN 4FT LTG1(I) LTG1(D) 3500K
 DELIVERED LUMENS: 5,082Lm
 TOTAL WATTS: 58W
 EFFICACY: 87 Lumens/Watt

ZONAL LUMEN SUMMARY

ZONE	LUMENS	% LAMP	% FIXTURE
0.00 - 30.00	649.42	8.55	12.78
0.00 - 40.00	1058.52	13.93	20.83
0.00 - 60.00	1893.93	24.93	37.27
0.00 - 90.00	2442.37	32.15	48.06
90.00 - 120.00	587.78	7.74	11.57
90.00 - 150.00	1942.59	25.57	38.22
90.00 - 180.00	2639.92	34.75	51.94
0.00 - 180.00	5082.29	66.90	100.00

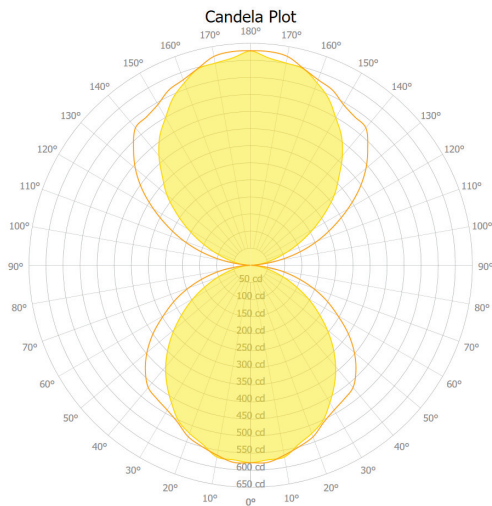

LS3 LED UPDN 4FT LTG2(I) LTG2(D) 3500K
 DELIVERED LUMENS: 3,501Lm
 TOTAL WATTS: 40W
 EFFICACY: 88 Lumens/Watt

ZONAL LUMEN SUMMARY

ZONE	LUMENS	% LAMP	% FIXTURE
0.00 - 30.00	444.89	8.50	12.71
0.00 - 40.00	725.42	13.85	20.72
0.00 - 60.00	1297.59	24.78	37.06
0.00 - 90.00	1673.64	31.96	47.80
90.00 - 120.00	404.48	7.72	11.55
90.00 - 150.00	1344.42	25.68	38.40
90.00 - 180.00	1827.54	34.90	52.20
0.00 - 180.00	3501.18	66.87	100.00

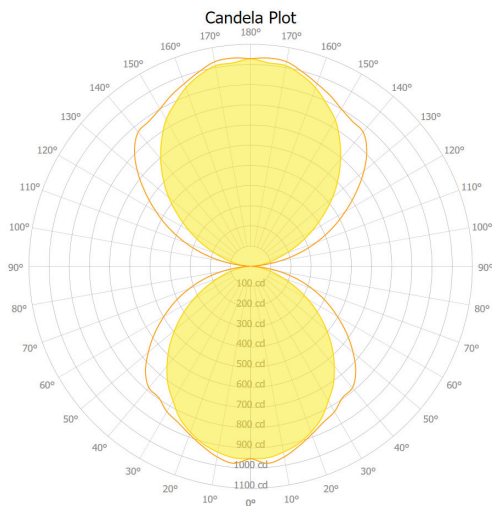

LS3 LED UPDN 4FT LTG3(I) LTG3(D) 3500K
 DELIVERED LUMENS: 5,830Lm
 TOTAL WATTS: 72W
 EFFICACY: 81 Lumens/Watt

ZONAL LUMEN SUMMARY

ZONE	LUMENS	% LAMP	% FIXTURE
0.00 - 30.00	744.07	8.54	12.76
0.00 - 40.00	1213.76	13.93	20.82
0.00 - 60.00	2171.45	24.92	37.25
0.00 - 90.00	2800.98	32.15	48.05
90.00 - 120.00	671.73	7.71	11.52
90.00 - 150.00	2227.83	25.57	38.22
90.00 - 180.00	3028.67	34.76	51.95
0.00 - 180.00	5829.65	66.92	100.00