

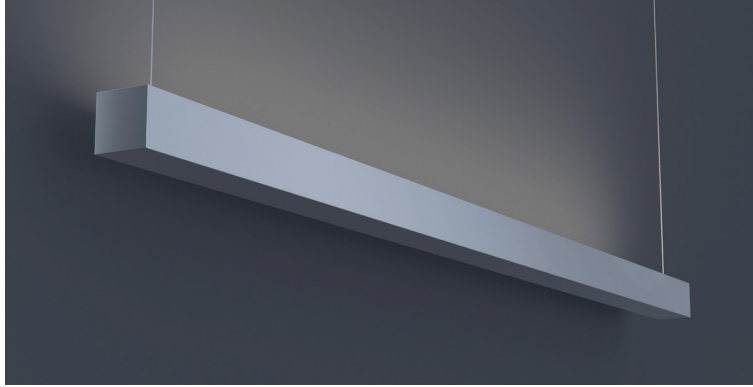

DATE	PROJECT	FIRM	TYPE
------	---------	------	------



Narrow, linear luminaire with all uplight. For indoor applications where an LED luminaire with small profile providing continuous light is required. Suspended or wall mount installation.

### FEATURES

- Available In Custom Lengths & Long Runs To 1/16" Accuracy
- Corners & Patterns Available (See Page 2)
- Damp Location Rated
- CRI 90+ Standard
- 5 Year, 50,000 Hour Fixture Warranty
- 2700K, 3000K, 3500K, 4000K & 5000K Color Temperatures Available
- Enlighted/Wattstopper Sensors Available

<b>APPLICATIONS</b>	Offices, Lobbies, Retail Stores, Classrooms, Reception Areas & Corridors			
<b>CONSTRUCTION</b>	Extruded Aluminum Housing, Steel End Caps, Formed Steel Gear Tray	<b>OPTICS</b>	Cast High Transmission Satin Acrylic Lens. Additional Optics Available	
<b>WARRANTY</b>	5 Year Limited Warranty (Covers Standard Components)		<b>FINISH</b>	Standard Powder-Coated White. Custom RAL Colors Available
<b>FIXTURE RATINGS &amp; CERTIFICATIONS</b>	Union Made ETL Listed	Made In The USA Damp Location Rated	 	

<b>ELECTRICAL</b>	Integral Driver With 0-10V 10% Dimming Standard. Several Driver Options Available. See Below For Lutron Dimming Information		
	2-Wire Forward Phase; Hi-Lume 1% Dimming, Only Available For 120V		LTEA
	3-Wire EcoSystem; Hi-lume 1% Dimming		L3DA
	Digital EcoSystem; Hi-lume 1% Dimming, 'Soft-on Fade-to-black' (Required for Daylighting)		LDE1
	5 Series EcoSystem; 5% Dimming		LDE5

### EXTRUSION DIMENSIONS

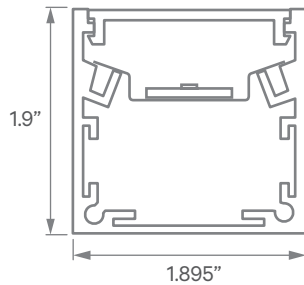

### LED SYSTEM INFORMATION

	Nominal System Watts	Nominal Delivered Lumens	Nominal Efficacy
Standard (LTG1)	7.25 W/ft	620 Lm/ft	85Lm/W
Low (LTG2)	5 W/ft	425 Lm/ft	85 Lm/W
High (LTG3)	8.75 W/ft	710 Lm/ft	81 Lm/W

Based on a 3500K luminaire using one driver. Please consult factory for custom lumen outputs & wattage.

<b>ORDERING</b>	1	2	3	4	5	6	7	8	9	10	11
-----------------	---	---	---	---	---	---	---	---	---	----	----

<b>1 - FIXTURE ID</b> LS1 LED UP	<b>2 - LENGTH</b> 2 - 2 ft 4 - 4 ft 8 - 8 ft x'-x" - Custom (specify length)  **Patterns available, consult factory	<b>3 - COLOR TEMP</b> 27 - 2700K/90 CRI 30 - 3000K/90 CRI 35 - 3500K/90 CRI 40 - 4000K/90 CRI 50 - 5000K/90 CRI TW* - Tunable White RGBW* - RGB + 3000K  *Must use DMX Driver (Remote)	<b>4 - LED SYSTEM</b> LTG1 - Standard LTG2 - Low LTG3 - High C - Custom Output (ie-C550Lm/ft)	<b>5 - VOLTAGE</b> UNV - Universal (120/277V)	<b>6 - DRIVER</b> DB - Standard 10% Dimming (0-10V) DB1% - 1% Dimming (0-10V) DB.01% - .01% Dimming (0-10V) LTEA* - Lutron 2-wire 1% Dimming L3DA* - Lutron 3-wire 1% Dimming LDE1* - Lutron Digital EcoSystem LDE5* - 5 Series EcoSystem; 5% Dimming *Refer to 'Electrical' Information Above DMX - For Color Tuning and RGBW
<b>7 - FINISH</b> W - White (Standard) BLK - Black CC - Custom Color (provide RAL#)	<b>8 - MOUNTING</b> AC - Air Craft Cable (50") WM - Wall Mount	<b>9 - CONTROL</b> EIS - Integral Sensor by Enlighted WIS - Integral Sensor by Wattstopper	<b>10 - OPTICS</b> SD - Standard Diffuser BW - Batwing Optic ASYM - Asymmetric Optic	<b>11 - OPTIONS</b> EM 120V - Emergency Pack EM 277V - Emergency Pack	

DATE	PROJECT	FIRM	TYPE
------	---------	------	------

## MOUNTING OPTIONS

AC - Air Craft Cable (50")

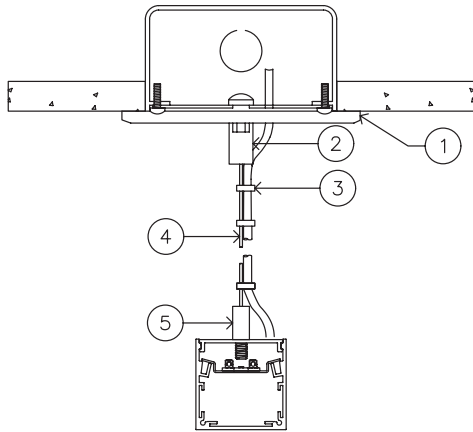

- 1 - 5" Round Canopy (Standard White Finish)
- 2 - Canopy Retainer
- 3 - S-JT Cord (Standard White)
- 4 - Air Craft Cable
- 5 - Gripper

WM - Wall Mount

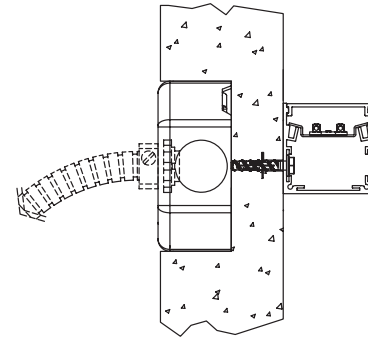

## CORNERS & PATTERNS

Available with illuminated corners, angles, and custom patterns. **Must consult factory for custom corners and patterns.**

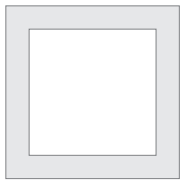

Square Patterns

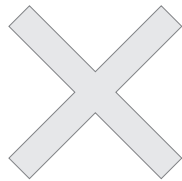

X Patterns

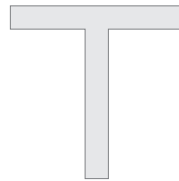

T Patterns



Custom Angles

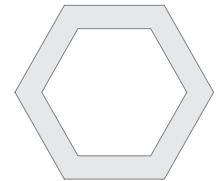

Custom Patterns

## LENS CUT OPTIONS



Straight-cut

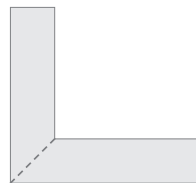

Mitered Angle

NOTE: Straight-Cut is standard configuration, Mitered Angle is optional and must be specified.

DATE

PROJECT

FIRM

TYPE

## PHOTOMETRICS

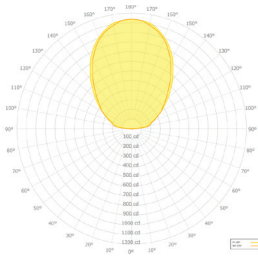

**LS1 LED UP 4FT LTG1 3500K**  
 DELIVERED LUMENS: 2,473Lm  
 TOTAL WATTS: 29W  
 EFFICACY: 85 Lumens/Watt

### ZONAL LUMEN SUMMARY

ZONE	LUMENS	% LAMP	% FIXTURE
0.00 - 30.00	0.00	0.00	0.00
0.00 - 40.00	0.00	0.00	0.00
0.00 - 60.00	0.00	0.00	0.00
0.00 - 90.00	0.37	0.01	0.01
90.00 - 120.00	416.97	10.98	16.86
90.00 - 150.00	1716.09	45.18	69.38
90.00 - 180.00	2473.01	65.10	99.99
0.00 - 180.00	2473.38	65.11	100.00

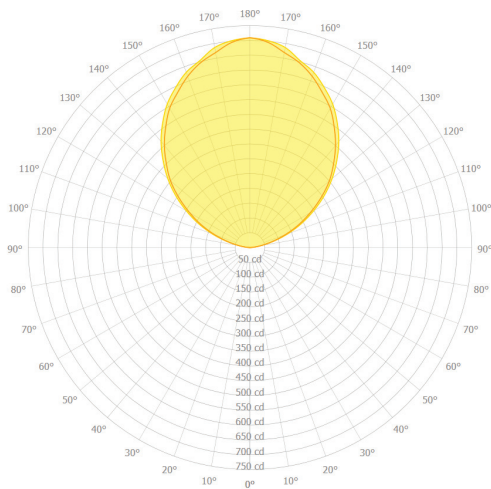

**LS1 LED UP 4FT LTG1 3500K**  
 DELIVERED LUMENS: 1,700Lm  
 TOTAL WATTS: 20W  
 EFFICACY: 85 Lumens/Watt

### ZONAL LUMEN SUMMARY

ZONE	LUMENS	% LAMP	% FIXTURE
0.00 - 30.00	0.00	0.00	0.00
0.00 - 40.00	0.00	0.00	0.00
0.00 - 60.00	0.00	0.00	0.00
0.00 - 90.00	0.25	0.01	0.01
90.00 - 120.00	287.19	10.99	16.89
90.00 - 150.00	1180.01	45.18	69.38
90.00 - 180.00	1700.52	65.10	99.99
0.00 - 180.00	1700.77	65.11	100.00

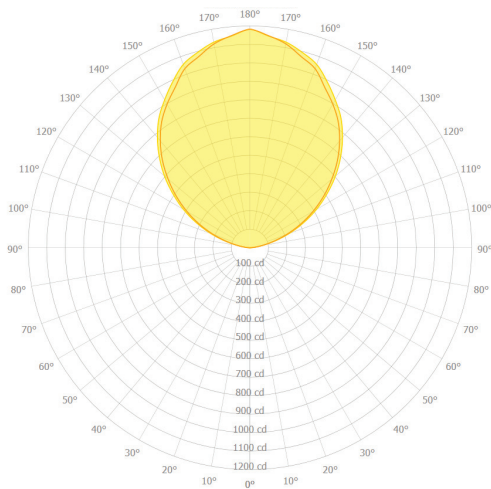

**LS1 LED UP 4FT LTG1 3500K**  
 DELIVERED LUMENS: 2,833Lm  
 TOTAL WATTS: 35W  
 EFFICACY: 81 Lumens/Watt

### ZONAL LUMEN SUMMARY

ZONE	LUMENS	% LAMP	% FIXTURE
0.00 - 30.00	0.00	0.00	0.00
0.00 - 40.00	0.00	0.00	0.00
0.00 - 60.00	0.00	0.00	0.00
0.00 - 90.00	0.42	0.01	0.01
90.00 - 120.00	478.40	10.99	16.88
90.00 - 150.00	1966.21	45.17	69.39
90.00 - 180.00	2833.05	65.08	99.99
0.00 - 180.00	2833.47	65.09	100.00