

DATE	PROJECT	FIRM	TYPE
------	---------	------	------

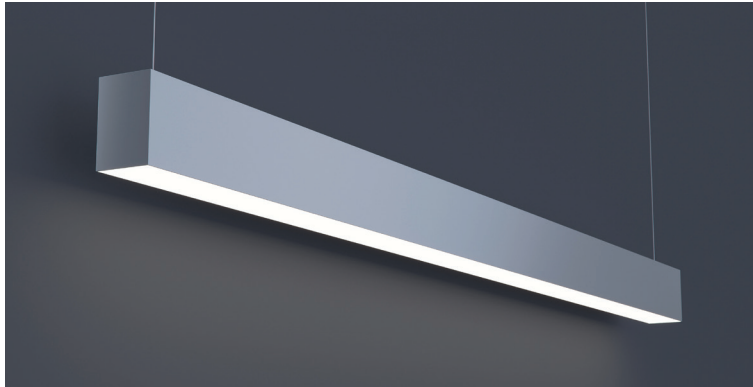

Linear luminaire with small profile providing continuous light. For indoor applications. Suspended, surface or wall mount installation. For custom mounting consult factory.

### FEATURES

- Available In Custom Lengths & Long Runs To 1/16" Accuracy
- Corners & Patterns Available (See Page 2)
- Damp Location Rated
- CRI 90+ Standard
- 5 Year, 50,000 Hour Fixture Warranty
- 2700K, 3000K, 3500K, 4000K & 5000K Color Temperatures Available
- Enlighted/Wattstopper Sensors Available

**APPLICATIONS** Offices, Lobbies, Retail Stores, Classrooms, Reception Areas & Corridors

**CONSTRUCTION** Extruded Aluminum Housing with Die Cast Ends. Formed Steel Gear Tray

**OPTICS** Extruded High Transmission Satin Acrylic Lens With No LED Imaging. Additional Optics Available.

**WARRANTY** 5 Year Limited Warranty (Covers Standard Components)

**FINISH** Standard Powder-Coated White. Custom RAL Colors Available

**FIXTURE RATINGS & CERTIFICATIONS** Union Made Made In The USA  
ETL Listed Damp Location Rated



**ELECTRICAL** Integral Driver With 0-10V 10% Dimming Standard. Several Driver Options Available. See Below For Lutron Dimming Information

2-Wire Forward Phase; Hi-Lume 1% Dimming, Only Available For 120V ..... LTEA

3-Wire EcoSystem; Hi-lume 1% Dimming ..... L3DA

Digital EcoSystem; Hi-lume 1% Dimming, 'Soft-on Fade-to-black' (Required for Daylighting) ..... LDE1

5 Series EcoSystem; 5% Dimming ..... LDE5

### EXTRUSION DIMENSIONS

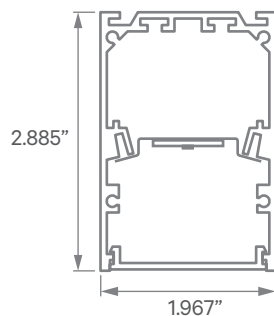

### LED SYSTEM INFORMATION

	System Watts	Delivered Lumens	Efficacy
Standard (LTG1)	7.25 W/ft	683 Lm/ft	94 Lm/W
Low (LTG2)	5 W/ft	470 Lm/ft	94 Lm/W
High (LTG3)	8.75 W/ft	783 Lm/ft	90 Lm/W

Based on a 3500K luminaire using one driver. Please consult factory for custom lumen outputs & wattage.

### ORDERING

<b>1 - FIXTURE ID</b> LS1 LED	<b>2 - LENGTH</b> 2 - 2 ft 4 - 4 ft 8 - 8 ft x'-x" - Custom (specify length)  **Patterns available, consult factory	<b>3 - COLOR TEMP</b> 27 - 2700K/90 CRI 30 - 3000K/90 CRI 35 - 3500K/90 CRI 40 - 4000K/90 CRI 50 - 5000K/90 CRI TW* - Tunable White RGBW* - RGB + 3000K  *Must use DMX Driver (Remote)	<b>4 - LED SYSTEM</b> LTG1 - Standard LTG2 - Low LTG3 - High C - Custom Output (ie-C550Lm/ft)	<b>5 - VOLTAGE</b> UNV - Universal (120/277V)	<b>6 - DRIVER</b> DB - Standard 10% Dimming (0-10V) DB1% - 1% Dimming (0-10V) DB.01% - .01% Dimming (0-10V) LTEA* - Lutron 2-wire 1% Dimming L3DA* - Lutron 3-wire 1% Dimming LDE1* - Lutron Digital EcoSystem LDE5* - 5 Series EcoSystem; 5% Dimming *Refer to 'Electrical' Information Above DMX - For Color Tuning and RGBW
<b>7 - FINISH</b> W - White (Standard) BLK - Black CC - Custom Color (provide RAL#)	<b>8 - MOUNTING</b> AC - Air Craft Cable (50") SM - Surface Mount WM - Wall Mount	<b>9 - CONTROL</b> EIS - Integral Sensor by Enlighted WIS - Integral Sensor by Wattstopper	<b>10 - OPTICS</b> SD - Standard Diffuser BW - Batwing Optic ASYM - Asymmetric Optic	<b>11 - OPTIONS</b> EM 120V - Emergency Pack EM 277V - Emergency Pack	

DATE \_\_\_\_\_ PROJECT \_\_\_\_\_ FIRM \_\_\_\_\_ TYPE \_\_\_\_\_

### MOUNTING OPTIONS

AC - Air Craft Cable (50")

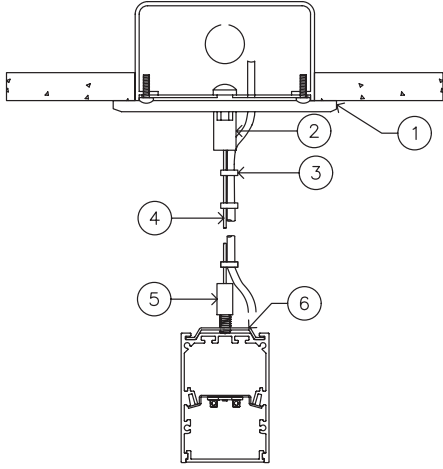

- 1 - 5" Round Canopy (Standard White Finish)
- 2 - Canopy Retainer
- 3 - S-JT Cord (Standard White)
- 4 - Air Craft Cable
- 5 - Gripper
- 6 - Hanging Bracket

SM - Surface Mount

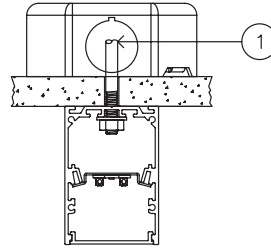

- 1 - Threaded Rod (not supplied)

WM - Wall Mount

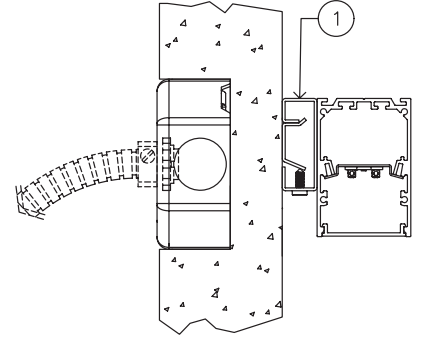

- 1 - 0.75" Wall Mount Bracket

### CORNERS & PATTERNS

Available with illuminated corners, angles, and custom patterns. **Must consult factory for custom corners and patterns.**

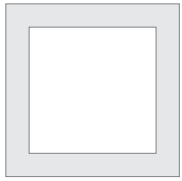

Square Patterns

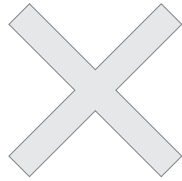

X Patterns

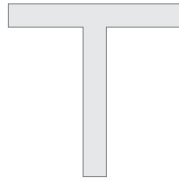

T Patterns

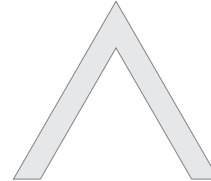

Custom Angles

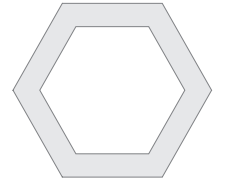

Custom Patterns

### LENS CUT OPTIONS

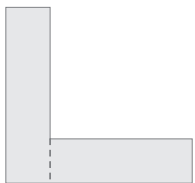

Straight-cut

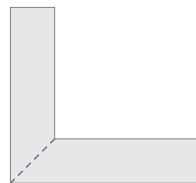

Mitered Angle

NOTE: Straight-Cut is standard configuration, Mitered Angle is optional and must be specified.

DATE

PROJECT

FIRM

TYPE

## PHOTOMETRICS

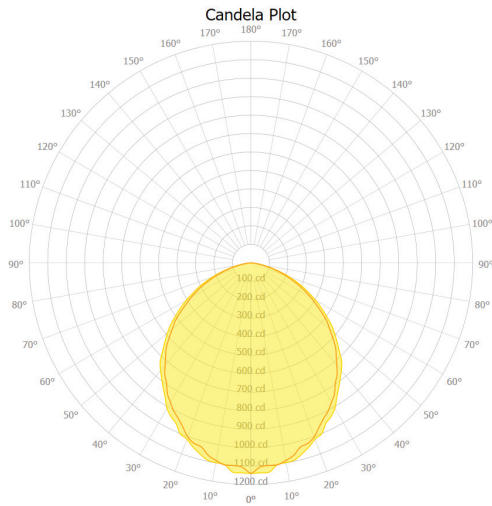

**LS1 LED 4FT LTG1 3500K**  
 DELIVERED LUMENS: 2,733Lm  
 TOTAL WATTS: 29W  
 EFFICACY: 94 Lumens/Watt

### ZONAL LUMEN SUMMARY

ZONE	LUMENS	% LAMP	% FIXTURE
0.00 - 30.00	838.12	22.06	30.66
0.00 - 40.00	1346.95	35.46	49.27
0.00 - 60.00	2281.95	60.07	83.48
0.00 - 90.00	2733.54	71.96	100.00
90.00 - 120.00	0.08	0.00	0.00
90.00 - 150.00	0.08	0.00	0.00
90.00 - 180.00	0.08	0.00	0.00
0.00 - 180.00	2733.54	71.96	100.00

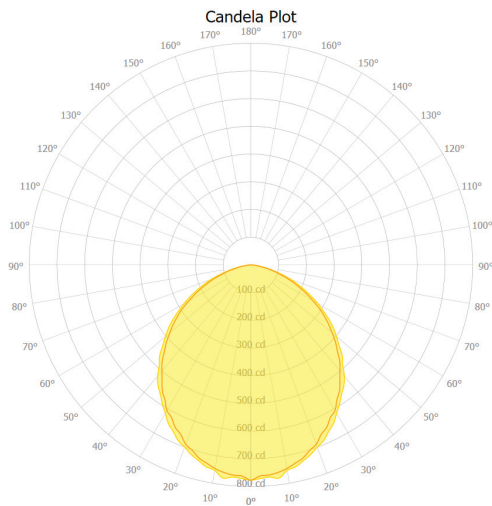

**LS1 LED 4FT LTG2 3500K**  
 DELIVERED LUMENS: 1,880Lm  
 TOTAL WATTS: 20W  
 EFFICACY: 94 Lumens/Watt

### ZONAL LUMEN SUMMARY

ZONE	LUMENS	% LAMP	% FIXTURE
0.00 - 30.00	576.90	22.09	30.68
0.00 - 40.00	926.64	35.48	49.28
0.00 - 60.00	1569.75	60.10	83.48
0.00 - 90.00	1880.40	71.99	100.00
90.00 - 120.00	0.06	0.00	0.00
90.00 - 150.00	0.06	0.00	0.00
90.00 - 180.00	0.06	0.00	0.00
0.00 - 180.00	1880.40	71.99	100.00

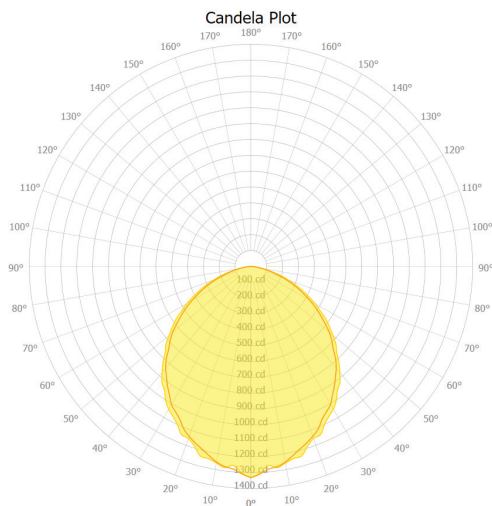

**LS1 LED 4FT LTG3 3500K**  
 DELIVERED LUMENS: 3,133Lm  
 TOTAL WATTS: 35W  
 EFFICACY: 90 Lumens/Watt

### ZONAL LUMEN SUMMARY

ZONE	LUMENS	% LAMP	% FIXTURE
0.00 - 30.00	961.40	22.08	30.68
0.00 - 40.00	1544.53	35.48	49.29
0.00 - 60.00	2616.16	60.10	83.49
0.00 - 90.00	3133.48	71.98	100.00
90.00 - 120.00	0.10	0.00	0.00
90.00 - 150.00	0.10	0.00	0.00
90.00 - 180.00	0.10	0.00	0.00
0.00 - 180.00	3133.48	71.98	100.00