

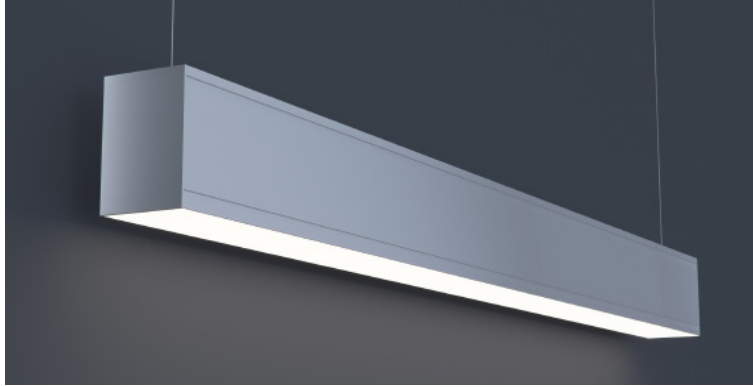

DATE	PROJECT	FIRM	TYPE
------	---------	------	------



Linear, architectural luminaire. For use in indoor applications where an LED luminaire providing continuous light is required. Suspended, surface or wall mounted installation. For custom mounting consult factory.

FEATURES

- Available In Custom Lengths & Long Runs To 1/16" Accuracy
- Corners & Patterns Available (See Page 2)
- Damp Location Rated
- CRI 90+ Standard
- 5 Year, 50,000 Hour Fixture Warranty
- 2700K, 3000K, 3500K, 4000K & 5000K Color Temperatures Available
- Enlighted/Wattstopper Sensors Available

APPLICATIONS	Offices, Lobbies, Retail Stores, Classrooms, Reception Areas & Corridors			
CONSTRUCTION	Extruded Aluminum Housing, Cast Steel End Caps, Formed Steel Gear Tray	OPTICS	Extruded High Transmission Satin Acrylic Lens With No LED Imaging. Additional Optics Available	
WARRANTY	5 Year Limited Warranty (Covers Standard Components)		FINISH	Standard Powder-Coated White. Custom RAL Colors Available
FIXTURE RATINGS & CERTIFICATIONS	Union Made ETL Listed	Made In The USA Damp Location Rated	 	

ELECTRICAL	Integral Driver With 0-10V 10% Dimming Standard. Several Driver Options Available. See Below For Lutron Dimming Information		
	2-Wire Forward Phase; Hi-Lume 1% Dimming, Only Available For 120V		LTEA
	3-Wire EcoSystem; Hi-lume 1% Dimming		L3DA
	Digital EcoSystem; Hi-lume 1% Dimming, 'Soft-on Fade-to-black' (Required for Daylighting)		LDE1
	5 Series EcoSystem; 5% Dimming		LDE5

EXTRUSION DIMENSIONS

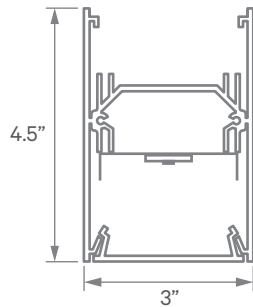

LED SYSTEM INFORMATION

	Nominal System Watts	Nominal Delivered Lumens	Nominal Efficacy
Standard (LTG1)	7.25 W/ft	610 Lm/ft	85 Lm/W
Low (LTG2)	5 W/ft	420 Lm/ft	85 Lm/W
High (LTG3)	8.75 W/ft	700 Lm/ft	80 Lm/W

Based on a 3500K luminaire using one driver. Please consult factory for custom lumen outputs & wattage.

ORDERING	1	2	3	4	5	6	7	8	9	10	11
-----------------	---	---	---	---	---	---	---	---	---	----	----

1 - FIXTURE ID LS3 LED	2 - LENGTH 2 - 2 ft 4 - 4 ft 8 - 8 ft x'-x" - Custom (specify length) **Patterns available, consult factory	3 - COLOR TEMP 27 - 2700K/90 CRI 30 - 3000K/90 CRI 35 - 3500K/90 CRI 40 - 4000K/90 CRI 50 - 5000K/90 CRI TW* - Tunable White RGBW* - RGB + 3000K *Must use DMX Driver (Remote)	4 - LED SYSTEM LTG1 - Standard LTG2 - Low LTG3 - High C - Custom Output (ie-C550Lm/ft)	5 - VOLTAGE UNV - Universal (120/277V)	6 - DRIVER DB - Standard 10% Dimming (0-10V) DB1% - 1% Dimming (0-10V) DB.01% - .01% Dimming (0-10V) LTEA* - Lutron 2-wire 1% Dimming L3DA* - Lutron 3-wire 1% Dimming LDE1* - Lutron Digital EcoSystem LDE5* - 5 Series EcoSystem; 5% Dimming *Refer to 'Electrical' Information Above DMX - For Color Tuning and RGBW
7 - FINISH W - White (Standard) BLK - Black CC - Custom Color (provide RAL#)	8 - MOUNTING AC - Air Craft Cable (50") SM - Surface Mount WM - Wall Mount	9 - CONTROL EIS - Integral Sensor by Enlighted WIS - Integral Sensor by Wattstopper	10 - OPTICS SD - Standard Diffuser POL - 1" Drop Below Pop Out Lens BW - Batwing Optic ASYM - Asymmetric Optic	11 - OPTIONS WW - Wall Wash Reflector EM 120V - Emergency Pack EM 277V - Emergency Pack	

DATE

PROJECT

FIRM

TYPE

MOUNTING OPTIONS

AC - Air Craft Cable (50")

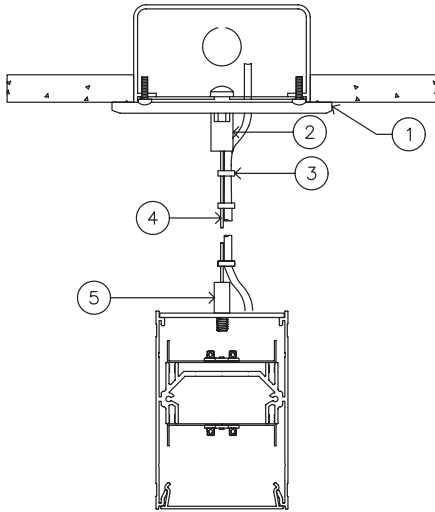

- 1 - 5" Round Canopy (Standard White Finish)
- 2 - Canopy Retainer
- 3 - SJT Cord (Standard White)
- 4 - Air Craft Cable
- 5 - Gripper

SM - Surface Mount

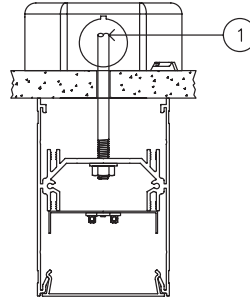

- 1 - Threaded Rod (not supplied)

WM - Wall Mount

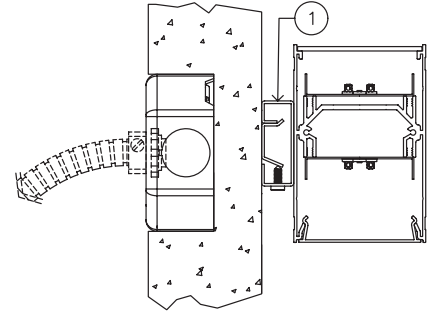

- 1 - 0.75" Wall Mount Bracket

CORNERS & PATTERNS

Available with illuminated corners, angles, and custom patterns. **Must consult factory for custom corners and patterns.**

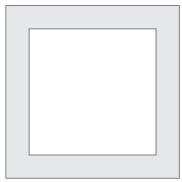

Square Patterns

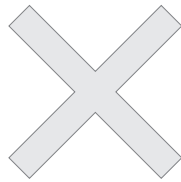

X Patterns

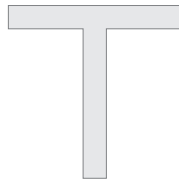

T Patterns



Custom Angles

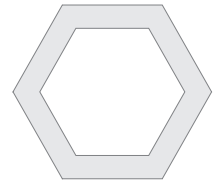

Custom Patterns

LENS CUT OPTIONS



Straight-cut

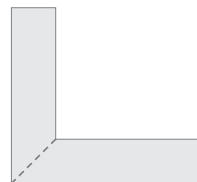

Mitered Angle

NOTE: Straight-Cut is standard configuration, Mitered Angle is optional and must be specified.

WALL WASH REFLECTOR

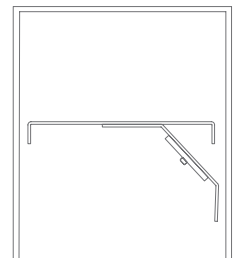

Cross Section

DATE

PROJECT

FIRM

TYPE

PHOTOMETRICS

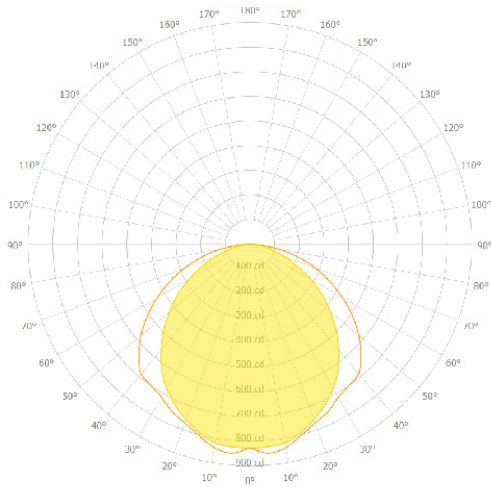

LS3 LED 4FT LTG1 3500K
 DELIVERED LUMENS: 2,440Lm
 TOTAL WATTS: 29W
 EFFICACY: 85 Lumens/Watt

ZONAL LUMEN SUMMARY

ZONE	LUMENS	% LAMP	% FIXTURE
0.00 - 30.00	648.21	17.06	26.57
0.00 - 40.00	1057.06	27.83	43.33
0.00 - 60.00	1890.95	49.78	77.51
0.00 - 90.00	2439.57	64.22	100.00
90.00 - 120.00	0.71	0.02	0.03
90.00 - 150.00	0.71	0.02	0.03
90.00 - 180.00	0.71	0.02	0.03
0.00 - 180.00	2439.57	64.22	100.00

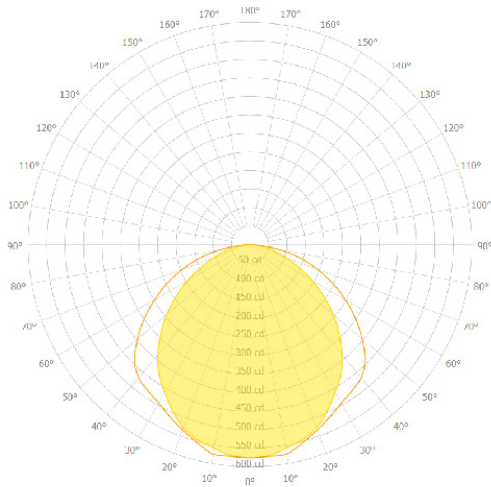

LS3 LED 4FT LTG2 3500K
 DELIVERED LUMENS: 1,687Lm
 TOTAL WATTS: 20W
 EFFICACY: 85 Lumens/Watt

ZONAL LUMEN SUMMARY

ZONE	LUMENS	% LAMP	% FIXTURE
0.00 - 30.00	445.11	17.04	26.54
0.00 - 40.00	726.58	27.82	43.32
0.00 - 60.00	1300.35	49.78	77.53
0.00 - 90.00	1677.23	64.21	100.00
90.00 - 120.00	0.48	0.02	0.03
90.00 - 150.00	0.48	0.02	0.03
90.00 - 180.00	0.48	0.02	0.03
0.00 - 180.00	1687.23	64.21	100.00

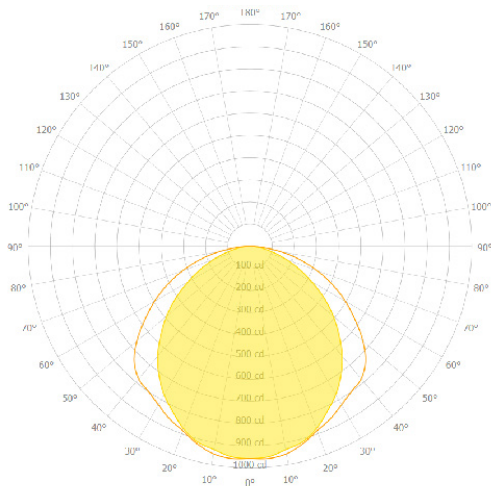

LS3 LED 4FT LTG3 3500K
 DELIVERED LUMENS: 2,796Lm
 TOTAL WATTS: 35W
 EFFICACY: 80 Lumens/Watt

ZONAL LUMEN SUMMARY

ZONE	LUMENS	% LAMP	% FIXTURE
0.00 - 30.00	743.03	17.07	26.57
0.00 - 40.00	1212.40	27.85	43.35
0.00 - 60.00	2169.11	49.83	77.57
0.00 - 90.00	2796.44	64.24	100.00
90.00 - 120.00	0.84	0.02	0.03
90.00 - 150.00	0.84	0.02	0.03
90.00 - 180.00	0.84	0.02	0.03
0.00 - 180.00	2796.44	64.24	100.00